

BMEGate version B1.5

Binary Interface Specifications

14 December 2023

Changes made in the latest revision

Outlined below are the main changes made in this version B1.5 (since version B1.4 on 29 January 2021):

- A new field RetailClientIndicator has been added in messages Order Market Pre-Transparency Information (Msg Type = 0x03), Trade Market Post-Transparency Information Full-Depth (Msg Type = 0x11), Execution Private Information 1 Leg Buy (Market & Order) (MsgType = 0x13), Execution Private Information 1 Leg Sell (Market & Order) (MsgType = 0x15)
- A new field RetailCIFlag has been added in messages Top-of-book (Msg Type = 0x82) and Top-of-book 5 levels (Msg Type = 0x83)

Outlined below are the main changes from the documentation published on 23 November 2022:

- 0x10, 0x11, 0x18, 0x14, 0x13, 0x15, 0x17, 0x1C, 0x1E. New description for value 8 in Designation field: 'Trade during TAL period'
- 0x66. New value 26 Post-close (Ready to trade in TAL) in SecurityTradingStatus field
- Adaptation of the document to the new corporate template

Outlined below are the main changes from the documentation published on 12 May 2023:

- References to new Codification Table 28 (MMT)
- Correct mistake in documentation: RetailFlag and RetailFlag2 are RV flags

Outlined below are the main changes from the documentation published on 06 November 2023:

- Detailed explanation for completing the ProtocolVersion field

Contents

Changes made in the latest revision	2
1 Introduction	6
1.1 Scope of this manual	6
1.2 The BME binary protocol	6
1.3 Message groups	6
1.3.1 <i>Session Level Messages</i>	7
1.3.2 <i>Market Information Messages</i>	8
1.3.3 <i>Order Entry Messages</i>	11
1.4 Format of the message definition tables.....	17
1.4.1 <i>Environment customization</i>	18
1.4.2 <i>Buy side and Sell side convention</i>	18
1.5 Related documents	18
2 The BME binary feeds	19
2.1 Introduction	19
2.2 The Multicast UDP Servers.....	19
2.2.1 <i>Common characteristics</i>	19
2.2.2 <i>Multicast Full-Depth Feeds (UDP channels A/B)</i>	20
2.2.3 <i>Multicast Top-of-Book Feeds (UDP channels C/D, E/F, G/H, I/J)</i>	20
2.3 Replay and Recovery of UDP channels, and Market Information TCP alternative.....	20
2.3.1 <i>Replay Server (TCP)</i>	21
2.3.2 <i>Recovery Server (TCP)</i>	22
2.3.3 <i>Market Information Server (TCP)</i>	23
2.4 Order Entry Interface Servers	24
2.4.1 <i>Order Entry Server (TCP)</i>	24
2.4.2 <i>Market & Order Server (TCP)</i>	24
2.5 Connections example	25
2.6 A note on high availability	25
3 Implementation decisions	26
3.1 Maximum length of message	26
3.2 Encryption	26
3.3 Message codes.....	26
3.3.1 <i>Order and Quote message codes</i>	26
3.3.2 <i>Execution and trade message codes</i>	27
3.4 Data formats	27
3.4.1 <i>Numeric values encoding</i>	27
3.4.2 <i>Dates and times</i>	27
3.5 Important IDs	28
3.5.1 <i>Client Data Identification (ClientDataID)</i>	28
3.5.2 <i>Client Application Order Identification (OrderID)</i>	28
3.5.3 <i>System Order Identification (SecondaryOrderID)</i>	28
3.5.4 <i>Trade System Identification (TrdMatchID)</i>	28
3.5.5 <i>Request Identification (RequestID)</i>	28
3.5.6 <i>Instrument (or Book) code (SecurityCode)</i>	29
4 Session Level Messages	30
4.1 Introduction	30
4.2 Scenarios for starting/restarting/recovering a TCP session.....	31
4.3 Definition of messages.....	34
4.3.1 <i>Logon (Msg Type = 0x41)</i>	34
4.3.2 <i>Logon Response (Msg Type = 0x08)</i>	35
4.3.3 <i>Replay Request (Msg Type = 0x09)</i>	35
4.3.4 <i>Replay Request Ack/Nack (Msg Type = 0x0C)</i>	37
4.3.5 <i>Heartbeat (Msg Type = 0x30)</i>	37
4.3.6 <i>Network Status (Msg Type = 0x0A)</i>	38
4.3.7 <i>Logout (Msg Type = 0x35)</i>	38
4.3.8 <i>Logout Response (Msg Type = 0x0B)</i>	39
4.3.9 <i>Reject (Msg Type = 0x0D)</i>	40
5 Market Information outbound messages (UDP and TCP)	41

5.1	Introduction	41
5.2	Market messages summary	41
5.3	Some scenarios	45
5.3.1	Changing from auction to open market and vice versa	45
5.3.2	Treatment of aggressive orders through the "Full Depth" Market Data Feed	48
5.4	Definition of messages	48
5.4.1	Trading Session Status (Msg Type = 0x68)	49
5.4.2	Security List Cancellation Report (MsgType = 0x78)	49
5.4.3	Security List (Msg Type = 0x79)	50
5.4.4	Security List Update Report (MsgType = 0x80)	50
5.4.5	Security Status (MsgType = 0x66)	63
5.4.6	Family Status (MsgType = 0x89)	65
5.4.7	Order Book Clear (MsgType = 0x81)	66
5.4.8	Top-of-book (Msg Type = 0x82)	67
5.4.9	Top-of-book Retail (Msg Type = 0x91)	68
5.4.10	Top-of-book 5 levels (Msg Type = 0x83)	69
5.4.11	Top-of-book Retail 5 levels (Msg Type = 0x92)	71
5.4.12	Order Market Pre-Transparency Information (Msg Type = 0x03)	73
5.4.13	Order Cancellation Market/Member (Msg Type = 0x01)	74
5.4.14	Quote Market Pre-Transparency Information (Msg Type = 0x07)	75
5.4.15	Quote Cancellation Market/Member (Msg Type = 0x05)	76
5.4.16	Trade Market Post-Transparency Information Top-of-book (Msg Type = 0x10)	77
5.4.17	Trade Market Post-Transparency Information Full-Depth (Msg Type = 0x11)	79
5.4.18	Trade, Trade Amendment or Cancellation (MsgType = 0x18)	81
5.4.19	Statistics (MsgType = 0x84)	83
5.4.20	Indication of Interest (Msg Type = 0x36)	86
5.4.21	RFQ Market Pre-Transparency information (Msg Type = 0x85)	87
5.4.22	News (Msg Type = 0x42)	88
6	Order Entry messages	89
6.1	Introduction	89
6.1.1	Order Entry messages summary	89
6.2	Some scenarios	92
6.2.1	Order and quote client data parameters	92
6.2.2	Derivatives delta protection parameters	92
6.2.3	Order management	92
6.2.4	Quote management	94
6.2.5	Mass cancellation	95
6.2.6	Trades due to order matching	95
6.2.7	Other trades (not the result of order matching)	95
6.3	Definition of inbound messages	96
6.3.1	Order and Quote Client Data (MsgType = 0x6F)	96
6.3.2	Delta Protection Parameters (MsgType = 0x86)	98
6.3.3	Simple new order (MsgType = 0x44)	99
6.3.4	Simple new order with Client Data (MsgType = 0x45)	100
6.3.5	Simple order modification (MsgType = 0x47)	102
6.3.6	Simple order modification with Client Data (MsgType = 0x48)	103
6.3.7	Order cancellation request (MsgType = 0x46)	106
6.3.8	New Quote (MsgType = 0x53)	106
6.3.9	Quote modification request (MsgType = 0x61)	107
6.3.10	Quote cancellation request (MsgType = 0x5A)	107
6.3.11	Mass order/quote cancellation (MsgType = 0x71)	108
6.4	Definition of outbound messages	109
6.4.1	Order and Quote Client Data Parameters Ack/Nack (MsgType = 0x87)	110
6.4.2	Delta Protection Parameters Ack/Nack (MsgType = 0x88)	112
6.4.3	Simple Order Status (MsgType = 0x02)	113
6.4.4	Quote Status (MsgType = 0x06)	115
6.4.5	Order Cancel Reject (MsgType = 0x39)	117
6.4.6	Mass order/quote cancellation completion (MsgType = 0x72)	118
6.4.7	Mass order/quote cancellation reject (MsgType = 0x73)	119
6.4.8	Execution Private Information 1 Leg Buy (Order Entry) (MsgType = 0x12)	120
6.4.9	Execution Private Information 1 Leg Sell (Order Entry) (MsgType = 0x14)	120
6.4.10	Execution Private Information 1 Leg Buy (Market & Order) (MsgType = 0x13)	122

6.4.11	<i>Execution Private Information 1 Leg Sell (Market & Order) (MsgType = 0x15)</i>	125
6.4.12	<i>Execution Private Information 2 Legs (MsgType = 0x17)</i>	128
6.4.13	<i>Trade, Trade Amendment or Cancellation 1 Leg Buy Private Information (MsgType = 0x1A)</i>	131
6.4.14	<i>Trade, Trade Amendment or Cancellation 1 Leg Sell Private Information (MsgType = 0x1C)</i>	131
6.4.15	<i>Trade, Trade Amendment or Cancellation 2 Legs Private Information (MsgType = 0x1E)</i>	136
6.4.16	<i>Business message reject (MsgType = 0x6A)</i>	143
7	Combined Market Information and Order Entry scenarios	144
7.1	Binary messages handling internals	144
7.2	Some scenarios	144
7.2.1	<i>Order entry and publication</i>	144
7.2.2	<i>Order entry matching another order or a quote</i>	145
7.3	Comparison of related messages	146
7.3.1	<i>Order related response messages</i>	146
7.3.2	<i>Quote related response messages</i>	147
7.3.3	<i>Execution (order matching) related messages</i>	148
7.3.4	<i>Trade due to reasons other than order matching related messages</i>	151

1 Introduction

1.1 Scope of this manual

This document contains the definition of the BME trading system binary interface provided for developing external applications.

This is a reference document for those Members and ISVs that wish to develop software to interact with BME markets using the BMEGate server interface.

The binary protocol described in this document is not the only way to access BME markets. There's also a FIX protocol based message interface, described in other documents.

1.2 The BME binary protocol

Along this document, the expression "Market Information" refers to information such as reference data, current market prices or trades executed on the system by any party. The expression "Order Entry" refers to orders and quotes entered by the user connected to the system and their responses and executions. This binary interface documentation covers both Market Information and Order Entry messages.

Market information can be obtained from multicast UDP channels or from TCP channels. Order Entry messages can only be exchanged through TCP channels. There's the possibility to obtain Market Information and enter orders through the same TCP channel.

The different connection possibilities are described in chapter "The BME binary feeds".

1.3 Message groups

There are three different groups of messages: Session Level Messages, Market Information Messages and Order Entry Messages.

Chapter 3 "Implementation decisions" presents some details regarding the protocol implementation that apply to all the message types.

In the rest of this section the three message groups are introduced.

1.3.1 Session Level Messages

Session level messages provide the functionality to establish, maintain and finalize a TCP connection. Some of them are also used in multicast UDP connections. Chapter “Session Level Messages” provides details of their usage.

The names, contents and functionalities covered by those messages are equivalent to the ones in FIX protocol. The following table displays the session level messages.

Functionality	Related messages
Logon	Logon (Msg Type = 0x41)
	Logon Response (Msg Type = 0x08)
Logout	Logout (Msg Type = 0x35)
	Logout Response (Msg Type = 0x0B)
HeartBeat	Logon Response (Msg Type = 0x08)
Network Status	Network Status (Msg Type = 0x0A)
Replay Requests	Replay Request (Msg Type = 0x09)
	Replay Request Ack/Nack (Msg Type = 0x0C)
Rejects	Reject (Msg Type = 0x0D)

1.3.2 Market Information Messages

The names, contents and functionalities covered by most of the Market information messages are equivalent to the ones in FIX protocol. Specifically for the following messages, that relate to reference data, status information and RFQs:

- Trading Session Status
- Security List
- Security List Update Report
- Security Status
- Family Status (Security Status in FIX)
- Indication of Interest
- RFQ Book (Indication of Interest in FIX)
- News.

Market Information on current prices can be delivered either as top-of-book information or as full-depth information. In full-depth feeds, during Open Market periods, all active orders with tradeable prices are delivered as Market information. For this purpose, there is a group of market messages related to active order information.

The following table displays the Market Information functions. Chapter “Market Information outbound messages (UDP and TCP)” provides details about their usage.

Market Information function	Related messages																																																																																																									
Obtain session status	Trading Session Status (Msg Type = 0x68)																																																																																																									
	Security List (Msg Type = 0x79)																																																																																																									
Obtain information on securities	Security List Update Report (MsgType = 0x80)																																																																																																									
	Security List Cancellation Report (MsgType = 0x78)																																																																																																									
	Security Status (MsgType = 0x66) or Family Status (MsgType = 0x89)																																																																																																									
	Order Book Clear (MsgType = 0x81)																																																																																																									
	Top-of-book (Msg Type = 0x82)																																																																																																									
Obtain information on top-of-book prices	<table border="1"> <thead> <tr> <th>Field</th> <th>Type</th> <th>Length</th> <th>Description</th> <th>R</th> <th>R</th> <th>D</th> </tr> <tr> <th></th> <th></th> <th></th> <th></th> <th>F</th> <th>V</th> <th>E</th> </tr> </thead> <tbody> <tr> <td>MessageSize</td> <td>U</td> <td>2</td> <td>Length of message, including this field</td> <td>x</td> <td>x</td> <td>x</td> </tr> <tr> <td>MessageType</td> <td>U</td> <td>1</td> <td>Message type</td> <td>x</td> <td>x</td> <td>x</td> </tr> <tr> <td>SequenceNumber</td> <td>U</td> <td>4</td> <td>Message sequence number</td> <td>x</td> <td>x</td> <td>x</td> </tr> <tr> <td>SecurityCode</td> <td>U</td> <td>4</td> <td>Instrument (or Book) code</td> <td>x</td> <td>x</td> <td>x</td> </tr> <tr> <td>TransactionDateAndTime</td> <td>T</td> <td>8</td> <td>Transaction Date and Time in nanoseconds since 1-jan-1970 UTC</td> <td>x</td> <td>x</td> <td>x</td> </tr> <tr> <td>BidOrders1</td> <td>U</td> <td>2</td> <td>Buy number of orders</td> <td>x</td> <td>x</td> <td>x</td> </tr> <tr> <td>BidSize1</td> <td>Q</td> <td>4</td> <td>Buy volume</td> <td>x</td> <td>x</td> <td>x</td> </tr> <tr> <td>BidPx1</td> <td>P</td> <td>8</td> <td>Buy price</td> <td>x</td> <td>x</td> <td>x</td> </tr> <tr> <td>AltBidPx1</td> <td>P</td> <td>8</td> <td>Alternate buy price 1</td> <td>x</td> <td></td> <td></td> </tr> <tr> <td>AskOrders1</td> <td>U</td> <td>2</td> <td>Sell number of orders</td> <td>x</td> <td>x</td> <td>x</td> </tr> <tr> <td>AskSize1</td> <td>Q</td> <td>4</td> <td>Sell volume</td> <td>x</td> <td>x</td> <td>x</td> </tr> <tr> <td>AskPx1</td> <td>P</td> <td>8</td> <td>Sell price</td> <td>x</td> <td>x</td> <td>x</td> </tr> <tr> <td>AltSellPx1</td> <td>P</td> <td>8</td> <td>Alternate sell price 1</td> <td>x</td> <td></td> <td></td> </tr> </tbody> </table>	Field	Type	Length	Description	R	R	D					F	V	E	MessageSize	U	2	Length of message, including this field	x	x	x	MessageType	U	1	Message type	x	x	x	SequenceNumber	U	4	Message sequence number	x	x	x	SecurityCode	U	4	Instrument (or Book) code	x	x	x	TransactionDateAndTime	T	8	Transaction Date and Time in nanoseconds since 1-jan-1970 UTC	x	x	x	BidOrders1	U	2	Buy number of orders	x	x	x	BidSize1	Q	4	Buy volume	x	x	x	BidPx1	P	8	Buy price	x	x	x	AltBidPx1	P	8	Alternate buy price 1	x			AskOrders1	U	2	Sell number of orders	x	x	x	AskSize1	Q	4	Sell volume	x	x	x	AskPx1	P	8	Sell price	x	x	x	AltSellPx1	P	8	Alternate sell price 1	x		
	Field	Type	Length	Description	R	R	D																																																																																																			
					F	V	E																																																																																																			
	MessageSize	U	2	Length of message, including this field	x	x	x																																																																																																			
	MessageType	U	1	Message type	x	x	x																																																																																																			
	SequenceNumber	U	4	Message sequence number	x	x	x																																																																																																			
	SecurityCode	U	4	Instrument (or Book) code	x	x	x																																																																																																			
	TransactionDateAndTime	T	8	Transaction Date and Time in nanoseconds since 1-jan-1970 UTC	x	x	x																																																																																																			
	BidOrders1	U	2	Buy number of orders	x	x	x																																																																																																			
	BidSize1	Q	4	Buy volume	x	x	x																																																																																																			
	BidPx1	P	8	Buy price	x	x	x																																																																																																			
	AltBidPx1	P	8	Alternate buy price 1	x																																																																																																					
	AskOrders1	U	2	Sell number of orders	x	x	x																																																																																																			
	AskSize1	Q	4	Sell volume	x	x	x																																																																																																			
AskPx1	P	8	Sell price	x	x	x																																																																																																				
AltSellPx1	P	8	Alternate sell price 1	x																																																																																																						
	Top-of-book 5 levels (Msg Type = 0x83)																																																																																																									
Obtain information on active orders	Order Book Clear (MsgType = 0x81)																																																																																																									
	Order Market Pre-Transparency Information (Msg Type = 0x03)																																																																																																									
	Order Cancellation Market/Member (Msg Type = 0x01)																																																																																																									
	Quote Market Pre-Transparency Information (Msg Type = 0x07)																																																																																																									
	Quote Cancellation Market/Member (Msg Type = 0x05)																																																																																																									

Obtain information on trades	Trade Market Post-Transparency Information Full-Depth (Msg Type = 0x11)
	Trade Market Post-Transparency Information Top-of-book (Msg Type = 0x10)
	Trade, Trade Amendment or Cancellation (MsgType = 0x18)
Session closing prices and statistics	Statistics (MsgType = 0x84)
Obtain information about RFQ	Indication of Interest (Msg Type = 0x36)
	RFQ Market Pre-Transparency information (Msg Type = 0x85)
Receive information from the Market Supervisor	News (Msg Type = 0x42)

1.3.3 Order Entry Messages

Order Entry Messages relate to order and quote entry, modification and cancellation, and also to trades resulting from these orders and quotes.

The following table displays the Order Entry functions and their related messages. Chapter “Order Entry messages” describes their usage in detail. Please note that chapter 7 “Combined Market Information and Order Entry scenarios” describes scenarios where the top-of-book, full-depth and Order Entry response messages are compared.

Order Entry function	Related messages
Setting default order and quote parameters	Order and Quote Client Data (MsgType = 0x6F)
Setting derivatives delta protection parameters	Order and Quote Client Data Parameters Ack/Nack (MsgType = 0x87)
Setting derivatives delta protection parameters	Delta Protection Parameters (MsgType = 0x86)
Setting derivatives delta protection parameters	Delta Protection Parameters Ack/Nack (MsgType = 0x88)
Order Management	Simple new order (MsgType = 0x44)
Order Management	Simple new order with Client Data (MsgType = 0x45)
Order Management	Simple order modification (MsgType = 0x47)
Order Management	Simple order modification with Client Data (MsgType = 0x48)
Order Management	Simple Order Status (MsgType = 0x02)

Message sent by the client to modify an order. The field OrderID must contain the client reference of the order that is to be modified. The message also allows to assign new values for the Client Data parameters. Note that no ClientDataID may be assigned. It will be answered by a message Simple Order Status (MsgType = 0x02) where the value of ClientDataID field will be set to zero. If the order is not found, no message will be answered to the client application.

Field	Type	Length	Valid values	Description	R F	R V	D E
MessageSize	U	2		Length of message, including this field	x	x	x
MessageType	U	1		Message type	x	x	x
RequestID	U	4		Request ID (for application feedback)	x	x	x
SecurityCode	U	4		Instrument (or Book) code	x	x	x
OrderID	U	4		Application Order ID (unique at security level)	x	x	x
Side	C	1	'1' - Buy '2' - Sell	Side	x	x	x
Price	P	8		Limit price	x	x	x
OrderQty	Q	4		New total intended Order Quantity (including the amount already executed for this chain of orders). For example, if the original order were of 20 securities, a partial execution of 5 securities took place, and the original order is wanted to reduce it in 1, this field should be accomplished with value 19. If it's being unchanged, must contain the same value as in the original order	x	x	x
AlgorithmicTradeIndicator	F	1		Algorithmic flag indicator	x	x	x
ClientID	U	4		Mifid II ClientID	x	x	x
AccountBolsa	C	16		Client code	x	x	
Account	C	5		Account	x	x	x
DEAFlag	F	1		Direct Electronic Access indicator	x	x	x
DecisorID	U	4		MIFID II DecisorID	x	x	x
ExecutorID	U	4		Mifid II ExecutorID	x	x	x
LiquidityProvisionActivity	F	1		Liquidity Provision Activity Flag	x	x	x
GiveInMember	C	4		Give-in member		x	x
AccountMember	C	4			x		

FirmMnemonic	C	10			x	x
AllocText	C	18			x	x
LastCapacity	C	1	D=Dealing on own account M=Matched principal A=Any Other Trading Capacity blanco		x	x
SelfMatchPreventionID	U	2			x	x
AutomaticOrderFilterFlag	C	1	2 - For orders entered by an authorized trader g - For authorized arbitration orders C - For orders not entered by an authorized trader ' ' - N/A			x
ReceivedDeptID	C	1	I = Orders placed through the Internet B = Orders placed through the bank branch network T = Orders placed through automatic trading systems C = Orders placed by important clients O = Others ' ' = N/A (Workstation)			x
Persistence	C	1	C - Cancel on disconnection P - Persist on disconnection	Persistence type	x	x
AccountType	C	1	9 = Retail Service Specialist 8 = Retail customer	Capacity Indicator		x

			(Supported for compatibility): A = On behalf of third parties P = House trader E = Specialist		
			' ' = N/A or default behaviour (aggressive order is rejected) 1 = Reject aggressive order 2 = Cancel pasive order 3 = Cancel both passive and aggressive order		
SelfMatchPreventionType	C	1			x x
ClientDataReference	C	15	Free to use by clients		x x x

Order cancellation request (MsgType = 0x46)

	Order Cancellation Market/Member (Msg Type = 0x01)
	Order Cancel Reject (MsgType = 0x39)
Quote management	New Quote (MsgType = 0x53)
	Quote modification request (MsgType = 0x61)
	Quote Status (MsgType = 0x06)
	Quote cancellation request (MsgType = 0x5A)
	Quote Cancellation Market/Member (Msg Type = 0x05)
	Mass order/quote cancellation (MsgType = 0x71)
Mass cancellation	Order Cancellation Market/Member (Msg Type = 0x01)
	Quote Cancellation Market/Member (Msg Type = 0x05)
	Mass order/quote cancellation completion (MsgType = 0x72)
	Mass order/quote cancellation reject (MsgType = 0x73)
Business rejects	Business message reject (Msg Type = 0x6A)
	Execution Private Information 1 Leg Buy (Order Entry) (MsgType = 0x12)
Trade due to Order Matching	Execution Private Information 1 Leg Buy (Market & Order) (MsgType = 0x13)
	Execution Private Information 1 Leg Sell (Order Entry) (MsgType = 0x14)
	Execution Private Information 1 Leg Sell (Market & Order) (MsgType = 0x15)
	Execution Private Information 2 Legs (MsgType = 0x17)
Trade due to reasons other than Order Matching	Trade, Trade Amendment or Cancellation 1 Leg Buy Private Information (MsgType = 0x1A)
	Trade, Trade Amendment or Cancellation 1 Leg Sell Private Information (MsgType = 0x1C)
	Trade, Trade Amendment or Cancellation 2 Legs Private Information (MsgType = 0x1E)

1.4 Format of the message definition tables

A table is included for each message, describing the component fields in detail.

These tables contain one field per row and have the following columns:

Column	Meaning					
Field	Field Name					
Type	Datatype:					
	T	Description	Signed	Length in bytes	Implicit decimals	Details
	y					
	p					
	e					
	B	Byte (bit-mask)		1, 2, 4	0	
	N	Signed Integer	Yes	2, 4	0	
	U	Unsigned integer	No	1, 2, 4, 8	0	
	T	Timestamp in nanoseconds since 1-Jan-1970 00:00:00 UTC	Yes	8	0	
	D	Number of Days since 1-Jan-1970	Yes	4	0	
	C	Char string		Variable		
	P	Price	Yes	8	6	
	V	Volume	No	8	6	
A	Monetary amount	Yes	8	4		
R	Percentage or Rate	Yes	8	4		
Q	Quantity	No	4	0		
F	Flag/Boolean	No	1	0	0x00: False 0x01: True 0xFF: Undefined (Only for optional, not mandatory, Flag/Boolean fields)	
Length	Length of the field in bytes					
Valid values	Accepted values for the field in the context of the message. It may be a list of values, or a range of numeric values, e.g. ">=3, <= 10". The default value for the field is also indicated in this column. To avoid confusions with the terms, the original FIX value description has been kept in the values associated with codes.					
Description	Description of the field in the context of the message					
RF / RV / DE	Environment customization information					

1.4.1 Environment customization

Messages described in this document can be used in all BME environments: Equities (RV), Fixed Income (RF) and Derivatives (DE).

Some of the message fields may be applicable only to some of the environments. In this case, the non-applicable fields will not be sent in the message. Where this restriction applies, a column is shown in the message description, explaining in which environments each field is used.

1.4.2 Buy side and Sell side convention

Some messages definitions include fields with the suffix 2 at the same time as fields with the same root name but without any suffix. The kept up covention is that the field with the suffix 2 corresponds to the sell side and the field without suffix refers to the buy side.

1.5 Related documents

#	Title	Author
1	Financial Information Exchange Protocol (FIX) 5.0 Service Pack 2 (9 December 2013). EP98-222 enhancing FIX 5.0 SP2	FIX Committee
2	HF SMARTGate – FIX Interface Specifications M5.1	Sociedad de Bolsas
3	HF SMARTGate – FIX Interface Specifications T5.7	Sociedad de Bolsas
4	HF RFBMEGate – FIX Interface Specifications M5.2	BME Renta Fija
5	HF RFBMEGate – FIX Interface Specifications T5.8	BME Renta Fija
6	HF MEFFGate – FIX Interface Specifications M5.4	MEFF
7	HF MEFFGate – FIX Interface Specifications T5.6	MEFF
8	BMEGate Codification tables	BME

2 The BME binary feeds

2.1 Introduction

All BME feeds are made up of a series of sequenced messages. The first two bytes of every message contain the total message length, including those first two bytes.

The second field in any published message is the message type.

The third field includes the message sequence number, which enables to continue a session interrupted due to communication or application problems without gaps and without repeated messages. For messages delivered through a multicast UDP channel, this sequence number is strictly sequential (except for Heartbeats and Network Status, that just repeat the last sequence number), so that listeners can detect any communication or application problem by verifying that there are no gaps. In TCP channels there may be gaps in this sequence number, but it will always be incremental (except, again, for Heartbeats and Network Status; also for Rejects).

The following table shows the first three fields of any published message.

Field	Type	Length	Description
MessageSize	U	2	Length of message, including this field
MessageType	B	1	Message type
SequenceNumber	U	4	Message sequence number
...			

Market Information messages can be delivered through a lightweight multicast protocol built on top of UDP that provides a mechanism for listeners to detect and re-request missed messages through an auxiliary replay TCP channel. This type of mechanism can also be used for recovery of all market messages from the beginning of the session.

Order Entry Messages can be exchanged through a channel based on a session protocol built on top of TCP.

2.2 The Multicast UDP Servers

Market information can be obtained by opening and reading a pair of multicast UDP channels. In this case there is the possibility to retrieve from alternate TCP channels (Replay and Recovery) a snapshot of the initial situation or specific messages that may have been lost.

This is the recommended way to obtain the binary market information.

2.2.1 Common characteristics

The multicast UDP BME feed messages are delivered to a party based on BME network configuration through a couple of channels (A/B, C/D, E/F, ...). If a client application misses a message in both channels, it can obtain a copy through the Replay channel.

All messages delivered through the UDP channels are sequentially numbered, so that the listeners can easily detect if they have lost any message.

Periods where there are no messages to be distributed are filled with HeartBeat messages that repeat the sequence number of the last sent message. The HeartBeat interval used is notified in the Logon Response message. The UDP server is also able to inform about its connectivity status with the main hosts by using Network Status messages.

2.2.2 Multicast Full-Depth Feeds (UDP channels A/B)

The binary multicast full-depth market message feeds provide the best coverage of Market Data Information during the session. They include information about all active orders (except during auctions, in which case only Top-of-book information is supplied). This compares with the FIX-based interface or the UDP top-of-book market information channels, which only provide a limited number of top-of-book levels at all times. These feeds provide reference data, pre-transparency information (including all active to-be-published orders and the best rfqs), post-transparency information (matched trades), session status and instrument status. Those are the same functionalities available through the FIX protocol Market data interfaces (except for the fact that in the FIX protocol BME provides top-of-book levels, instead of full-depth). The client application must perform certain processing tasks in order to build the market image based on the received orders, and aggregate some figures in order to keep daily statistics.

A single environment may provide separate feeds for different sets of symbols. Messages that apply to all sets of symbols (Trading Session Status, News) are forwarded through all feeds.

2.2.3 Multicast Top-of-Book Feeds (UDP channels C/D, E/F, G/H, I/J)

The UDP top-of-book market information channels are equivalent to the full-depth channels, except for the information about current market prices, which is not delivered on an order-by-order basis, but just as top-of-book information.

The top-of-book binary interface provides reference data, pre-transparency information, including market depth of either 1 level (channels C/D) or 5 levels (channels E/F) and the best rfqs, post-transparency information (matched trades), session status and instrument status. Those are the same functionalities available through the FIX protocol Public interfaces. The client application must aggregate some figures in order to keep daily statistics.

UDP channels G/H and I/J are specific for the Retail Service. They are equivalent to channels C/D (1 level) and E/F (5 levels), respectively. But messages Top-of-book Retail (MsgType = 0x91) and Top-of-book Retail 5 levels (MsgType = 0x92) are received instead Top-of-book (MsgType = 0x82) and Top-of-book 5 levels (MsgType = 0x83).

Separate feeds may also be available for different sets of symbols, in the same way as for Full-Depth Feeds.

2.3 Replay and Recovery of UDP channels, and Market Information TCP alternative

The Replay Server can be used to request a copy of a specific message or range of messages that may have been lost from a UDP multicast feed. These will be delivered through a TCP channel.

The Recovery Server can be used to request a snapshot of the current market situation.

Both the TCP Replay server and the Recovery server also fill gaps with HeartBeat messages, and can also inform about their connectivity situation with the central servers by using the Network Status message. Neither of those messages increment the Sequence Number, and they cannot be recovered or replayed when connecting to the Replay or Recovery servers.

2.3.1 Replay Server (TCP)

Client applications reading UDP multicast channels can also establish a permanent TCP connection to a Replay Server. In order to establish such a connection, a valid Username-Password combination must be sent in a Logon message. The Replay server will answer with a Logon Response message. The server will send nothing (except HeartBeat messages) until the client sends a Replay Request message to request the replay of any range of messages.

For instance, the following diagram shows that message 33 coming from an A channel has been lost by the client application. Since it has been able to get it from channel B, no replay has been requested. Message 35 is lost from both channels and, as soon as message 36 is received, the client application requests the replay of message 35.

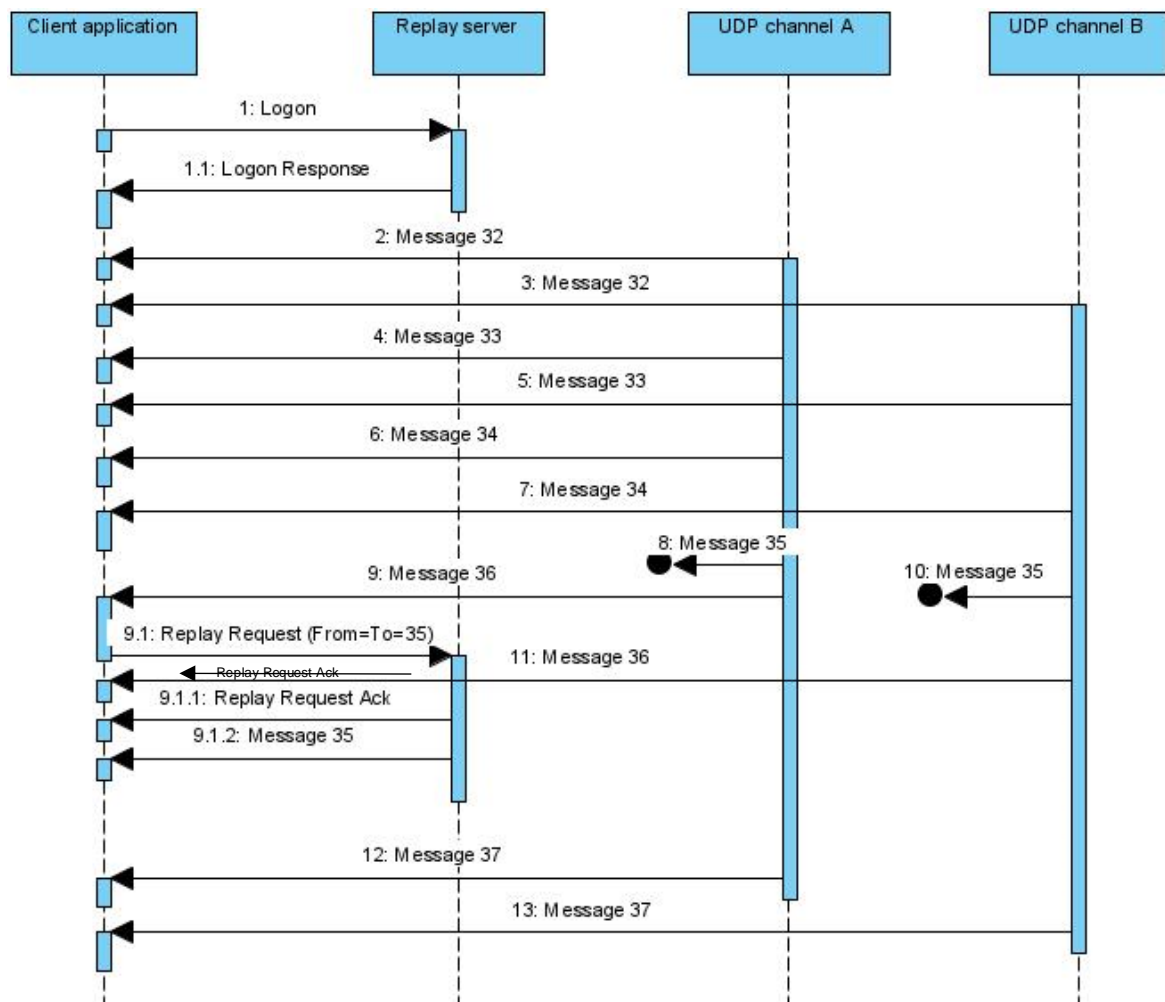

2.3.2 Recovery Server (TCP)

In case of a late connection to a UDP-based BME FullDepth feed, the Recovery server can be asked to send a snapshot of all the messages that correspond to current market and security status, matched trades and currently active orders in the books. This request is done in the Logon message. In the case of a TopOfBook feed, the Recovery server can provide current market and security status, matched trades and current top-of-book information.

In the example shown in the next diagram, a client application connects when the UDP-based feed is sending a message numbered with sequence 28. It can then start storing the UDP messages in a buffer, and make Logon to the Recovery Server with ExpectedSequenceNumber = 0. The Recovery server will provide a Snapshot based on a message greater than or equal to the current UDP sequence number. The Sequence Number corresponding to the returned Snapshot will be shown in the Logon Response message, for instance 30.

Then the Recovery server will send the relevant messages that will allow the receiving application to know all matched trades and the current market status. Market status includes trading session, security and family status; also relevant news and current statistics data. The Recovery Server may not necessarily send all the messages from the start of the session, since some of them may correspond to events that are no longer relevant for the current market situation. The Snapshot ends with the Logout Response message indicating that the Snapshot is complete.

Once all these messages have been processed, the application can continue with the messages read from the UDP channel.

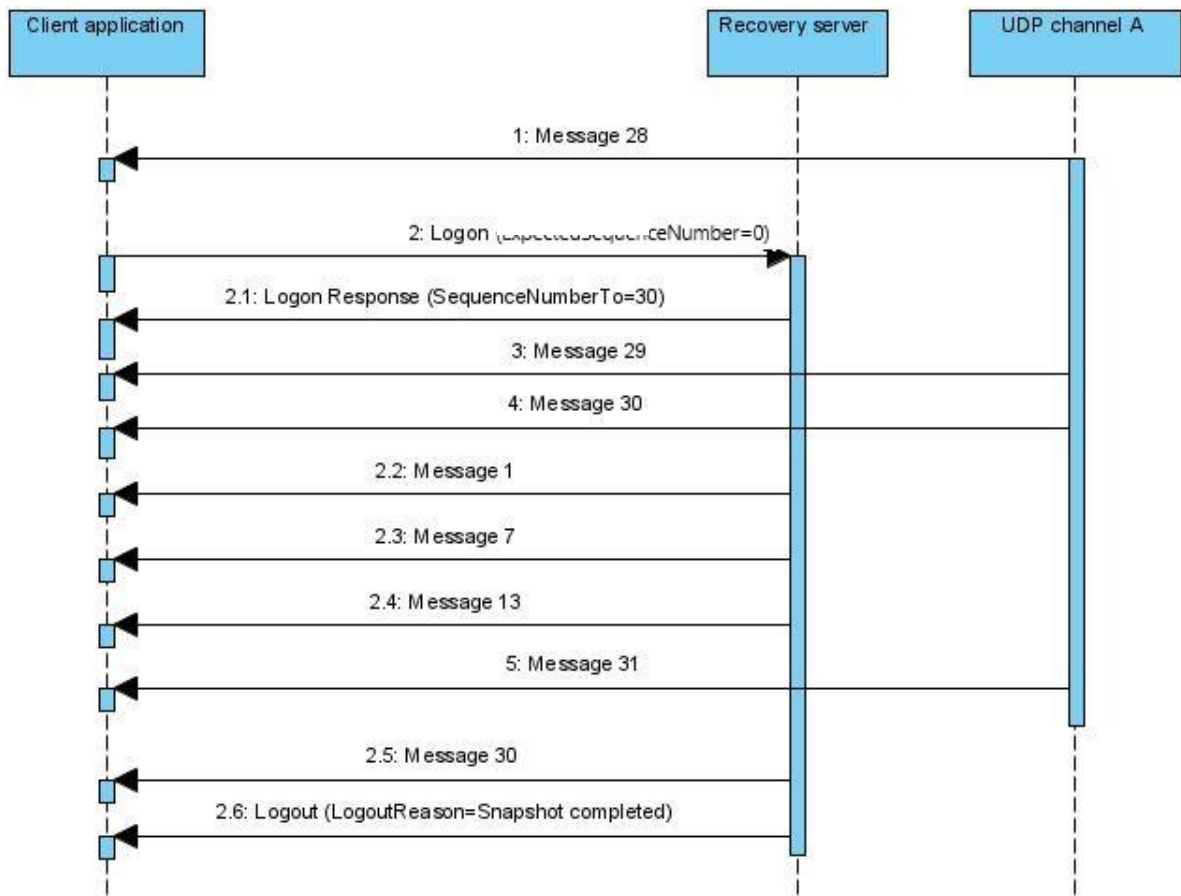

2.3.3 Market Information Server (TCP)

The Market Information Server (TCP) provides a means to get all market messages from the beginning of a session through a TCP connection. Such a connection can be established by means of the Subscriptions field in the Logon message.

This type of connection can be useful in case of narrow-bandwidth connections or for client applications that haven't implemented a replay/recovery mechanism.

In this case there is no mechanism to receive partial information about some sets of symbols.

2.4 Order Entry Interface Servers

2.4.1 Order Entry Server (TCP)

The Order Entry Server provides a TCP binary interface to enter, modify and cancel orders and quotes. In order to keep these messages short, client-related information is sent in a separate message (up to 65535 combinations per connection can be set).

Not all functionality available through the FIX-based interfaces is included in the binary interface. The binary interface is intended for market makers and HFTs, and therefore only the most frequently used functionalities have been included, resulting in messages with shorter length than those that would have been required to provide full functionality. In particular, only Limit orders and Quotes are allowed, and the possible values of TimeInForce are Day, IOC, FOK and ATC (GTD orders are not supported).

The procedure to connect with the Order Entry Servers is the same as the one explained to connect to the Replay or Recovery Servers (see previous section). The session protocol also includes HeartBeat and Network Status messages.

Message sequence numbers in the Order channel always increase (except for HeartBeats and Network Status messages that repeat the previously used Sequence Number), but they may not be consecutive. The TCP protocol guarantees that no intermediate messages are lost.

The Order channel can also distribute some order-entry relevant market messages, based on the subscriptions made at Logon. Specifically, Trading Session Status, Security List, Security List Update Report, Security Status, Family Status and News can be forwarded through the Order channel. In the Derivatives environment it also can provide Indications of Interest related to order requests.

2.4.2 Market & Order Server (TCP)

In some environments a special type of Order Entry Server can also optionally provide market information on Order status and Trade status through the same TCP connection, by means of the Subscriptions field in the Logon message. In this case a single connection is used for both the Market information (full-depth) and the Order Entry messages.

Whenever there is a transaction that would produce in separate servers one market message and one Member private message, only the private one will be transmitted. For instance, a client application will receive through this channel the market message Order Market Pre-Transparency Information (Msg Type = 0x03) for orders sent by other parties and the private message Simple Order Status (MsgType = 0x02) for orders sent by the application. The same kind of approach applies for Quote confirmations and Trade notifications. You can find more detailed information about these scenarios in chapter 7.

2.5 Connections example

In the table and the diagram below some sample client applications connected to BME Systems are shown.

Client Application	Market Information Feed	Order Entry feed
Public Info 1	Multicast Top-of-book C/D (UDP)	
Public Info 2	Market Information Server A/B (TCP)	
Private & Public 1	Multicast Full-Depth A/B (UDP)	Order Entry Server
Private & Public 2	Market & Order Server	Market & Order Server

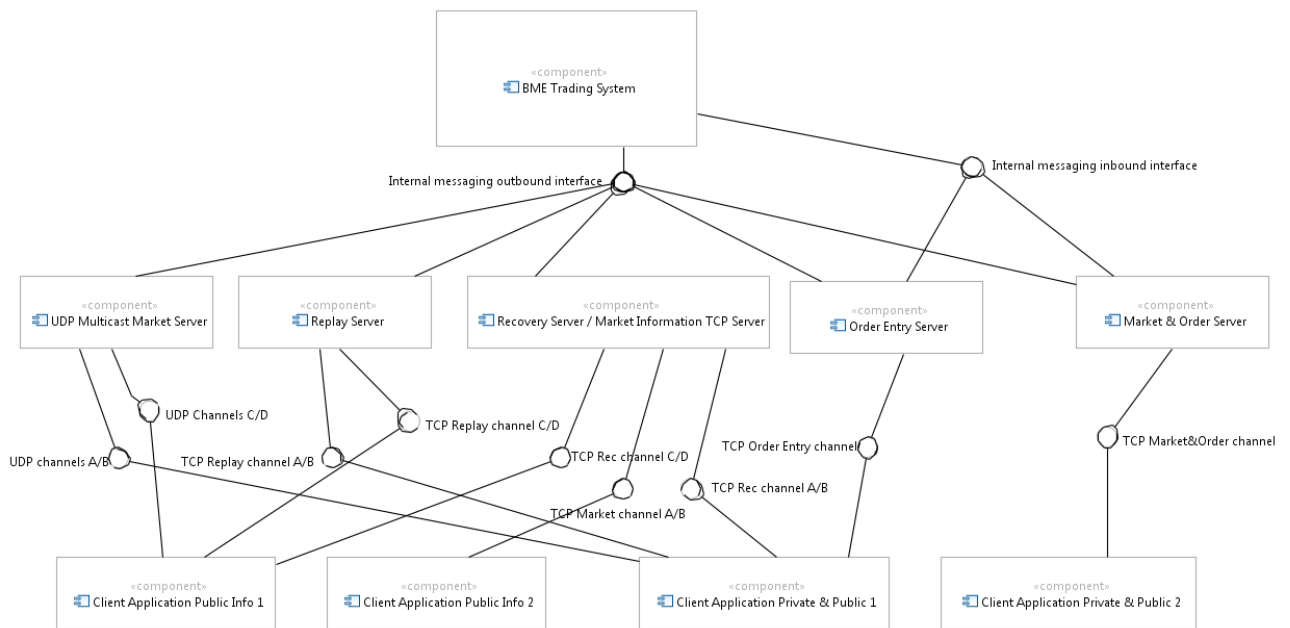

2.6A note on high availability

For the UDP multicast Market Information, high availability is achieved by means of redundancy of transmission (pair of channels for each feed) and the possibility to replay or recover any lost messages.

For the TCP channels, there will be various instances of servers executing in different computers. When a server or a communication path fails, the client can continue working with another server. The client must carry out the necessary processes to synchronise at the application level using the ExpectedSequenceNumber field.

3 Implementation decisions

This chapter presents some implementation decisions made by BME.

3.1 Maximum length of message

The maximum length of the messages sent or received by BMEGate is 1300 bytes.

3.2 Encryption

BMEGate does not use encryption. Optional encryption is implemented using TLS (*Transport Layer Security*).

3.3 Message codes

For messages that have a single character message code in the equivalent FIX protocol message, this message code has been chosen. For instance: Logon 'A'.

The rest of messages have been assigned numeric hexadecimal values under 0x20 or greater than or equal to 0x80.

Messages that correspond to order publications, quote publications, execution publications and, in general, trade publications, have a message code that can be interpreted as a bit mask, as explained in this section's subsections. Please consult chapter '7 Combined Market Information and Order Entry scenarios' to see the common layout of the various messages related to the same type of transaction.

3.3.1 Order and Quote message codes

The message codes for order and quote responses are those with code 0x0X, where the three least significant bits can be interpreted in the following way.

Bit	Meaning
0	1 - Public, 0 - Private
1	1 - Active order or Quote, 0 - Cancellation
2	1 - Quote, 0 - Order
3-7	Always 0

The meaningful combinations are included in the following table:

Message number	Message
0x01	Order Cancellation Market/Member (Msg Type = 0x01)
0x02	Simple Order Status (MsgType = 0x02)
0x03	Order Market Pre-Transparency Information (Msg Type = 0x03)
0x05	Quote Cancellation Market/Member (Msg Type = 0x05)
0x06	Quote Status (MsgType = 0x06)
0x07	Quote Market Pre-Transparency Information (Msg Type = 0x07)

3.3.2 Execution and trade message codes

The message codes for executions and trades are those with code 0x1X, where the four least significant bits can be interpreted in the following way.

Bit	Meaning
0	Publish both legs order public info
1	Publish buy leg Market & Order info
2	Publish sell leg Market & Order info
3	Publish amendment trade info
4	Always set
5-7	Always 0

The meaningful combinations are included in the following table:

Message number	Message
0x10	Trade Market Post-Transparency Information Top-of-book (Msg Type = 0x10)
0x11	Trade Market Post-Transparency Information Full-Depth (Msg Type = 0x11)
0x12	Execution Private Information 1 Leg Buy (Order Entry) (MsgType = 0x12)
0x13	Execution Private Information 1 Leg Buy (Market & Order) (MsgType = 0x13)
0x14	Execution Private Information 1 Leg Sell (Order Entry) (MsgType = 0x14)
0x15	Execution Private Information 1 Leg Sell (Market & Order) (MsgType = 0x15)
0x17	Execution Private Information 2 Legs (MsgType = 0x17)
0x18	Trade, Trade Amendment or Cancellation (MsgType = 0x18)
0x1A	Trade, Trade Amendment or Cancellation 1 Leg Buy Private Information (MsgType = 0x1A)
0x1C	Trade, Trade Amendment or Cancellation 1 Leg Sell Private Information (MsgType = 0x1C)
0x1E	Trade, Trade Amendment or Cancellation 2 Legs Private Information (MsgType = 0x1E)

3.4 Data formats

3.4.1 Numeric values encoding

All numeric values are sent as Little Endian encoded integer variables. In some cases, there are an implicit number of decimal places, depending on the field type. Please consult the table at "1.4Format of the message definition tables.

3.4.2 Dates and times

All dates and times are sent in UTC.

Dates in format D4 correspond to the number of days since 1 January 1970 (Unix time). It can be a negative number (although only in exceptional cases). When developing in C++, it is recommended to use the chrono library to handle this format.

Timestamps and hours are expressed in nanoseconds since 1 January 1970 00:00:00.000000000.

Please note that the Session Date (field SessionDate in the Logon message, or TradeSessionDate in trade information) may be different from that obtained from timestamps in nanoseconds.

3.5 Important IDs

3.5.1 Client Data Identification (ClientDataID)

Each application can create up to 65535 sets of client attributes that can be used in subsequent quotes and orders. These sets of attributes are not persistent between session dates. Therefore, every day, the client application must send the sets of attributes that it is going to use.

Once established those attributes in a given session, there's no need for re-stating them in case of a temporary disconnection.

A restatement of the definition of a set of attributes will only apply to the orders and quotes entered after the change.

Every user can have a maximum of one quote per SecurityCode and ClientDataID. Therefore, the way to identify a quote in cancellations or modifications is via this combination of fields. In some environments, depending on the market rules, more restrictive conditions may apply (one active quote per SecurityCode and user, or even one active quote per SecurityCode and Member).

3.5.2 Client Application Order Identification (OrderID)

OrderID is a client application identification for an active order. It is used by the client application in subsequent modifications and the order cancellation. It should be unique for all active orders of a user in a SecurityCode at any given moment, but it can be reused within a session.

The system doesn't perform any checking on the unicity of this value. If the client application repeats the OrderID, and has simultaneously several orders in the same SecurityCode with the same id, the system may apply subsequent requests to anyone of the existing orders.

Orders related to a quote will have OrderID=0.

3.5.3 System Order Identification (SecondaryOrderID)

This number is assigned by the system when an order is accepted, and it doesn't change within the life of the order (except for Iceberg orders). The combination of EntryDate and SecondaryOrderID is a unique key inside a session.

3.5.4 Trade System Identification (TrdMatchID)

This number is assigned by the system each time a trade is matched or registered. It's unique per each Trade Date.

Please note that the same TrdMatchID can be sent in the same session referring to different trades, for instance when a deferred publication applies (publication of trades corresponding to another trade date). In this case, the field TradeSessionDate can be used to distinguish them.

3.5.5 Request Identification (RequestID)

This number is assigned by the client application to identify transactions (order or quote entry, modification or cancellation) and is returned by the system in all response messages related to a specific request.

3.5.6 Instrument (or Book) code (SecurityCode)

This number is assigned by the system to each security on a daily basis. Therefore, the assigned number may be different between session dates.

The SecurityCode's data type is four bytes long unsigned integer. The value of the most significant byte is always the ascii character coding the internal trading unit where the security is managed. For instance, 49 (value of the ascii character 1) will be the value of SecurityCode's most significant byte of all securities managed in trading unit 1. The trading unit is explicitly informed in messages Mass order/quote cancellation completion (MsgType = 0x72) and Mass order/quote cancellation reject (MsgType = 0x73).

The SecurityCode assigned to the security at the current session must be got from the Security List message (Msg Type = 0x79) published in the session providing the definition of the security.

4 Session Level Messages

4.1 Introduction

The names, contents and usage of these messages are similar to those of the FIX protocol session level messages.

Some of the outbound messages are also used in UDP multicast BME feeds: Logon Response, Logout Response, Heartbeat and Network Response.

The following table displays the session level messages and the servers in which they apply.

Functionality	Related messages	UDP Full-Depth	UDP Top-of-book	Replay Server	Recovery Server	Market Information Server	Order entry server	Market & Order Server
Logon	Logon (Msg Type = 0x41)			X	X	X	X	X
	Logon Response (Msg Type = 0x08)	X	X	X	X	X	X	X
Replay Requests	Replay Request (Msg Type = 0x09)			X				
	Replay Request Ack/Nack (Msg Type = 0x0C)			X				
HeartBeat	Heartbeat (Msg Type = 0x30)	X	X	X	X	X	X	X
Network Status	Network Status (Msg Type = 0x0A)	X	X	X		X	X	X
Logout	Logout (Msg Type = 0x35)			X	X	X	X	X
	Logout Response (Msg Type = 0x0B)	X	X	X	X	X	X	X
Reject	Reject (Msg Type = 0x0D)			X	X	X	X	X

4.2 Scenarios for starting/restarting/recovering a TCP session

Replay Server is suggested to be used at the following scenarios:

Scenario	Replay Request SequenceNumberFrom	Replay Request SequenceNumberTo	Behaviour
Start of day connection	1	Sequence number prior to the first message received on the UDP channel	Connect to UDP channel. If first sequence number received > 1, connect to Replay Server and request all previous messages
		0	Connect to UDP channel. Receive all messages since message 1 to the last one
Immediate reconnection after a disconnection	Last received sequence number on the UDP channel + 1	First message received on the UDP channel after reconnection - 1	Reconnect to UDP channel. Connect to Replay Server and request all missed messages.

Remarks:

1. Value 0 is allowed for SequenceNumberFrom and/or SequenceNumberTo:
 - a. If SequenceNumberFrom = 0: Replay will be since the beginning of day.
 - b. If SequenceNumberTo = 0: Replay will be until the current UDP sequence number.

Actual values for SequenceNumberFrom and SequenceNumberTo will be provided in the immediate answer Replay request Ack/Nack (Msg Type=0x0C).

If SequenceNumberFrom and SequenceNumberTo are provided with non-zero values, SequenceNumberFrom must be lower or equal than SequenceNumberTo. And it is also mandatory that SequenceNumberTo is lower than or equals to the current UDP sequence number. Otherwise, the replay request immediate answer will be a Replay Request Ack/Nack (Msg Type = 0x0C) with Status = 0 (Rejected).

2. On a connection to the Replay Server, no more than one replay request will be served at the same time.

Recovery Server will always provide a way to obtain a current snapshot of the market situation and the intermediate history of all trades, but the rest of intermediate messages may be omitted so that the client application can become operative as soon as possible. It is suggested to be used at the following scenarios:

Scenario	Logon ExpectedSequenceNumber	Behaviour
Late connection	0	<p>FullDepth channel The new session will send all securities, trades, statistics and news since the beginning of day. Also current market status, securities status and active rfqs and indications of interest. And also a snapshot of all the current active orders. The recovery is a subset of the messages provided on channel FullDepth by the UDP Market Server since the beginning of day until the moment of the client connection. Orders cancelled before execution and intermediate order modifications may be omitted.</p> <hr/> <p>TopOfBook channels The new session will send all securities, trades, statistics and news since the beginning of day. Also current market status, securities status and active rfqs and indications of interest. And also the last TopOfBook message for each security. Intermediate TopOfBook messages for the same security may be omitted.</p> <hr/> <p>FullDepth channel The new session will send no messages with sequence number lower than N. The recovery is a subset of the messages provided on channel FullDepth by the UDP Market Server since the message with sequence number N until the moment of the client connection. The recovery messages sequence assumes that client knows the orders which were active when message with sequence number N was published. That message included. It is the starting point on which orders and trades messages in the recovery must be applied in order to build the current set of active orders.</p> <hr/> <p>TopOfBook channels The new session will send no messages with sequence number lower than N. Intermediate TopOfBook messages for the same security from message N to the last message may be omitted.</p>
Late reconnection after a disconnection	Last received sequence number N	<p>FullDepth channel The new session will send no messages with sequence number lower than N. The recovery is a subset of the messages provided on channel FullDepth by the UDP Market Server since the message with sequence number N until the moment of the client connection. The recovery messages sequence assumes that client knows the orders which were active when message with sequence number N was published. That message included. It is the starting point on which orders and trades messages in the recovery must be applied in order to build the current set of active orders.</p> <hr/> <p>TopOfBook channels The new session will send no messages with sequence number lower than N. Intermediate TopOfBook messages for the same security from message N to the last message may be omitted.</p>

Remarks:

1. When connecting to Recovery Server, if a ExpectedSequenceNumber is specified which is greater than the current UDP sequence number, connection will be rejected with an immediate Logout Response (Msg Type = 0x0B)
2. It is not possible to get from a Recovery Server a snapshot of active orders at a time in the past. Provided snapshot is always corresponding to the sequence number specified at the Logon Response. That sequence number will always be very close to that of the current UDP message.

4.3 Definition of messages

4.3.1 Logon (Msg Type = 0x41)

The Logon message is used to start a session by the client application.

Field	Type	Length	Description												
MessageSize	U	2	Length of message, including this field												
MessageType	U	1	Message type												
Username	C	7	Identifier of the user as assigned by BME												
Password	C	10	User password												
SoftwareName	C	25	Descriptive string of the software name used												
ExpectedSequenceNumber	U	4	<ul style="list-style-type: none"> – Replay channel: Ignored – Recovery channel: Sequence number above which the client application requests to be updated. – Order channel and Market and Order channel in non-Snapshot mode: Sequence number from which the client application expects to receive messages through this connection. Value 0 is interpreted as client application does not require the replay of any previous messages. 												
Subscriptions	B	1	Bit mask: 0: Snapshot mode (only relevant in the Market and Order channel) 1: Public orders (only relevant in the Market & Order channel) 2: Public trades (only relevant in the Market & Order channel) 3: RFQ information (only relevant in the Market & Order channel and Indications of Interest (relevant in the Market & Order channel and in the Order channel) 4: Security List (only relevant in the Order channel) 5: Trading Session Status and News (only relevant in the Order channel) 6: Security Status / Family Status (only relevant in the Order channel) 7: Statistics (only relevant in the Order channel)												
ProtocolVersion	C	6	Exact identification of the version of the protocol used and expected by the client application. If complimented with null characters (0x00) or with "BBP001" version 1.3 will be assumed. Valid values for TCP connections are: <table border="1" data-bbox="726 1646 1465 1915"> <thead> <tr> <th>TCP connection</th> <th>Equities</th> <th>Fixed Income</th> <th>Derivatives</th> </tr> </thead> <tbody> <tr> <td>Replay / Recovery server</td> <td>BP1.5W</td> <td></td> <td>BP1.5D</td> </tr> <tr> <td>Order entry server</td> <td>BP1.3W / BP1.4W / BP1.5W</td> <td></td> <td>BP1.3D / BP1.4D / BP1.5D</td> </tr> </tbody> </table>	TCP connection	Equities	Fixed Income	Derivatives	Replay / Recovery server	BP1.5W		BP1.5D	Order entry server	BP1.3W / BP1.4W / BP1.5W		BP1.3D / BP1.4D / BP1.5D
TCP connection	Equities	Fixed Income	Derivatives												
Replay / Recovery server	BP1.5W		BP1.5D												
Order entry server	BP1.3W / BP1.4W / BP1.5W		BP1.3D / BP1.4D / BP1.5D												

4.3.2 Logon Response (Msg Type = 0x08)

The Logon Response message is used by the Server to accept a new session.

In this message the sequence number will always be 0.

Please note that this message provides information about the version of this binary protocol that the client application is going to receive. It also indicates whether the connection corresponds to a Test environment or to the Production environment.

Field	Type	Length	Description								
MessageSize	U	2	Length of message, including this field								
MessageType	U	1	Message type								
SequenceNumber	U	4	Message sequence number								
HeartBtInt	U	1	Interval at which messages are sent to verify the connection (Heartbeat message) expressed in seconds.								
ProtocolVersion	C	6	<p>Identification of the binary protocol version. In UDP connections it contains the maximum version available in the system. In TCP connections it must be as requested in the Logon message (MessageType = 'A'). If complimented with null characters (0x00) or with "BBP001" in Logon message, "BBP001" will be returned in this field. Valid values for UDP connections are:</p> <table border="1"> <thead> <tr> <th></th> <th>Equities</th> <th>Fixed Income</th> <th>Derivatives</th> </tr> </thead> <tbody> <tr> <td>UDP connection</td> <td>BP1.5W</td> <td></td> <td>BP1.5D</td> </tr> </tbody> </table>		Equities	Fixed Income	Derivatives	UDP connection	BP1.5W		BP1.5D
	Equities	Fixed Income	Derivatives								
UDP connection	BP1.5W		BP1.5D								
TestProductionInd	C	1	T: Test P: Production								
EnvironmentCode	C	2	Environment code								
SessionDate	D	4	Session Date								
ExpectedSequenceNumber	U	4	Requested sequence number								
SequenceNumberTo	U	4	Actual sequence number corresponding to the Snapshot								

4.3.3 Replay Request (Msg Type = 0x09)

Message sent by the client application to request the replay of some specific UDP messages through the TCP Replay channel.

Field	Type	Length	Description
MessageSize	U	2	Length of message, including this field
MessageType	U	1	Message type
SequenceNumberFrom	U	4	Sequence number of first message to be replayed. Value 0 is interpreted as the beginning of day.
SequenceNumberTo	U	4	Sequence number of last message to be replayed. Value 0 is interpreted as the latest message.

RequestID U 4 Request ID (for application feedback)

4.3.4 Replay Request Ack/Nack (Msg Type = 0x0C)

Message sent by the Replay Server as an immediate answer to a Replay Request (Msg Type = 0x09).

In this message the sequence number will always be 0.

Field	Type	Length	Description
MessageSize	U	2	Length of message, including this field
MessageType	U	1	Message type
SequenceNumber	U	4	Message sequence number
SequenceNumberFrom	U	4	Actual sequence number of first message to be replayed
SequenceNumberTo	U	4	Actual sequence number of last message to be replayed
RequestID	U	4	Request ID (for application feedback)
Status	F	1	0x00 = Rejected/NAck

4.3.5 Heartbeat (Msg Type = 0x30)

The Heartbeat message is used by the Server to indicate that the communication is active.

In the Heartbeat message, the SequenceNumber of the previously received message will be repeated. If through a UDP channel, the first instance of a SequenceNumber is a Heartbeat (or a Network Status message), this may indicate that the previous message has been actually lost and therefore, it should be requested with a Replay Request message.

The heartbeat message must also be used by the client application connected through a TCP channel whenever there is a period of time longer than HeartBtInt with no message sent by the application. In this case the contents of field SequenceNumber are ignored by the Server.

Field	Type	Length	Description
MessageSize	U	2	Length of message, including this field
MessageType	U	1	Message type
SequenceNumber	U	4	Message sequence number (previous SequenceNumber will be repeated)

4.3.6 Network Status (Msg Type = 0x0A)

Message sent by the server with information about the connectivity between the Server and the central systems.

In the Network Status message, the SequenceNumber of the previously received message will be repeated. If through a UDP channel, the first instance of a SequenceNumber is a Network Status (or a Heartbeat message), this may indicate that the previous message has been actually lost and therefore, it should be requested with a Replay Request message.

Field	Type	Length	Valid values	Description
MessageSize	U	2		Length of message, including this field
MessageType	U	1		Message type
SequenceNumber	U	4		Message sequence number (previous SequenceNumber will be repeated)
NetworkStatusValue	U	1	1 - Connected 2 - Not connected - down expected up 3 - Not connected - down expected down 4 - In process	Connection status

4.3.7 Logout (Msg Type = 0x35)

The Logout message is used by the client application to request the end of a session.

Field	Type	Length	Description
MessageSize	U	2	Length of message, including this field
MessageType	U	1	Message type

4.3.8 Logout Response (Msg Type = 0x0B)

The Logout message is used by the Server to notify the end of a session, whether it is solicited or unsolicited. It may also be the answer to a failed logon attempt (see Logon message).

After sending this message, the Server immediately closes the tcp socket.

Field	Type	Length	Valid values	Description
MessageSize	U	2		Length of message, including this field
MessageType	U	1		Message type
SequenceNumber	U	4		Message sequence number
LogoutReason	U	1	0 - Termination after a solicited Logout request 1 - End of session termination. In Recovery Server, end of recovery snapshot 2 - Timeout. Connection lost 3 - Lack of heartbeat 16 - Invalid username or password 17 - Invalid ExpectedSequenceNumber 18 - Invalid ProtocolVersion 19 - New connection from user	Logout reason

4.3.9 Reject (Msg Type = 0x0D)

It may be sent by the server to inform about the rejection of an unsupported or syntactically incorrect message.

In the Reject message, the SequenceNumber of the previously received message will be repeated

Field	Type	Length	Valid values	Description
MessageSize	U	2		Length of message, including this field
MessageType	U	1		Message type
SequenceNumber	U	4		Message sequence number (previous SequenceNumber will be repeated)
SessionRejectReason	U	1	11 = Invalid MsgType 30 = Wrong MessageSize 31 = Throttle limit exceeded 33 = Invalid client session status 99 = Other	Code indicating the rejection motive. Session may be disconnected if SessionRejectReason = 31.
Text	C	58		Explanation of rejection
MsgRejectedReference	(raw data)	7		Provides the seven first bytes of the message being rejected

5 Market Information outbound messages (UDP and TCP)

5.1 Introduction

Market information groups together various functionalities, which are classified into several categories:

Session status. Status of trading session

Security information. Definition and status of securities (or families in Derivatives)

Prices. Prices in securities.

- Full-depth channels deliver the price information as top-of-book information during auctions and as full-depth information during open market. Between each of these phases an Order Book Clear message is sent.
- Top-of-book channels deliver always the information through Top-of-book or Top-of-book 5 Levels messages.

Trades. Information on trade prices.

Statistics. End-of-day information on closing prices and other information.

Indication of interest. Information regarding indications of interest (requests for firm orders on a security) on environments where this market mechanism applies.

RFQs. Information regarding RFQs on environments where this market mechanism applies.

News. Text messages sent from market surveillance.

5.2 Market messages summary

The names, contents and functionalities covered by most of those messages are equivalent to the ones in FIX protocol. Specifically for the following messages:

- Trading Session Status,
- Security List,
- Security List Update Report,
- Security Status,
- Family Status (Security Status in FIX),
- Indication of Interest,
- RFQ Book (Indication of Interest in FIX)
- News.

The messages Top-of-book, Top-of-book 5 levels and Statistics correspond to different instances of the Market Data Snapshot Full Refresh FIX message.

The following table displays the Market Information functions, their related messages and the feeds in which they apply.

Please note that some of them are also used in the Order Entry Server for Private Information purposes.

Market Information function	Related messages	Full-Depth	Top-of-book	Order entry server	Market & Order Server
Obtain session status	Trading Session Status (Msg Type = 0x68)	X	X	X	X
	News (Msg Type = 0x42)	X	X	X	X
Obtain information on securities	Security List (Msg Type = 0x79)	X	X	X	X
	Security List Update Report (MsgType = 0x80)	X	X	X	X
	Security List Cancellation Report (MsgType = 0x78)	X	X	X	X
Full-depth feed: Obtain information on prices during auctions	Security Status (MsgType = 0x66) and Family Status (MsgType = 0x89)	X	X	X	X
	Order Book Clear (MsgType = 0x81)	X			X
Full-depth feed: Obtain information on prices during open market	Top-of-book (Msg Type = 0x82)	X			X
	Order Book Clear (MsgType = 0x81)	X			X
	Order Market Pre-Transparency Information (Msg Type = 0x03)	X			X
	Order Cancellation Market/Member (Msg Type = 0x01)	X		X	X
	Quote Market Pre-Transparency Information (Msg Type = 0x07)	X			X
	Quote Cancellation Market/Member (Msg Type = 0x05)	X		X	X

Market Information function	Related messages	Full-Depth	Top-of-book	Order entry server	Market & Order Server
-----------------------------	------------------	------------	-------------	--------------------	-----------------------

Top-of-book 5 levels feed: Obtain information on prices during auctions

Top-of-book (Msg Type = 0x82)

X

Top-of-book 5 levels feed: Obtain information on prices during open market

Field	Type	Length	Description	R	R	D
				F	V	E
MessageSize	U	2	Length of message, including this field	x	x	x
MessageType	U	1	Message type	x	x	x
SequenceNumber	U	4	Message sequence number	x	x	x
SecurityCode	U	4	Instrument (or Book) code	x	x	x
TransactionDateAndTime	T	8	Transaction Date and Time in nanoseconds since 1-jan-1970 UTC	x	x	x
BidOrders1	U	2	Buy number of orders	x	x	x
BidSize1	Q	4	Buy volume	x	x	x
BidPx1	P	8	Buy price	x	x	x
AltBidPx1	P	8	Alternate buy price 1	x		
AskOrders1	U	2	Sell number of orders	x	x	x
AskSize1	Q	4	Sell volume	x	x	x
AskPx1	P	8	Sell price	x	x	x
AltSellPx1	P	8	Alternate sell price 1	x		

X

Top-of-book 5 levels (Msg Type = 0x83)

Market Information function	Related messages	Full-Depth	Top-of-book	Order server	Market & Order Server
Top-of-book feed: Obtain information on prices	Top-of-book (Msg Type = 0x82)		X		
Obtain information on trades	Trade Market Post-Transparency Information Full-Depth (Msg Type = 0x11)	X			X
	Trade Market Post-Transparency Information Top-of-book (Msg Type = 0x10)	X	X		X
	Trade, Trade Amendment or Cancellation (MsgType = 0x18)	X	X		X
Session closing prices and statistics	Statistics (MsgType = 0x84)	X	X	X	X
Obtain information about RFQ	Indication of Interest (Msg Type = 0x36)	X	X	X	X
	RFQ Market Pre-Transparency information (Msg Type = 0x85)	X	X		X
Receive information from the Market Supervisor	News (Msg Type = 0x42)	X	X	X	X

5.3 Some scenarios

5.3.1 Changing from auction to open market and vice versa

In the following diagram, a new order is published during an auction period. The Market information is displayed as Top-of-book messages.

As soon as the auction ends:

- Trading Session Status (Msg Type = 0x68) is published.
- The trades resulting from the auction are published (1 execution in this case).
- Then a Security Status (MsgType = 0x66) (except in Derivatives since auctions are always dealt with in families) is published.
- Finally, the new situation after the trades is published.
 - In the case of the C/D channels, with a Top-of-book 5 levels (Msg Type = 0x83).
 - In the case of the A/B channels, an Order Book Clear (MsgType = 0x81) is published, followed by all active orders and quotes.

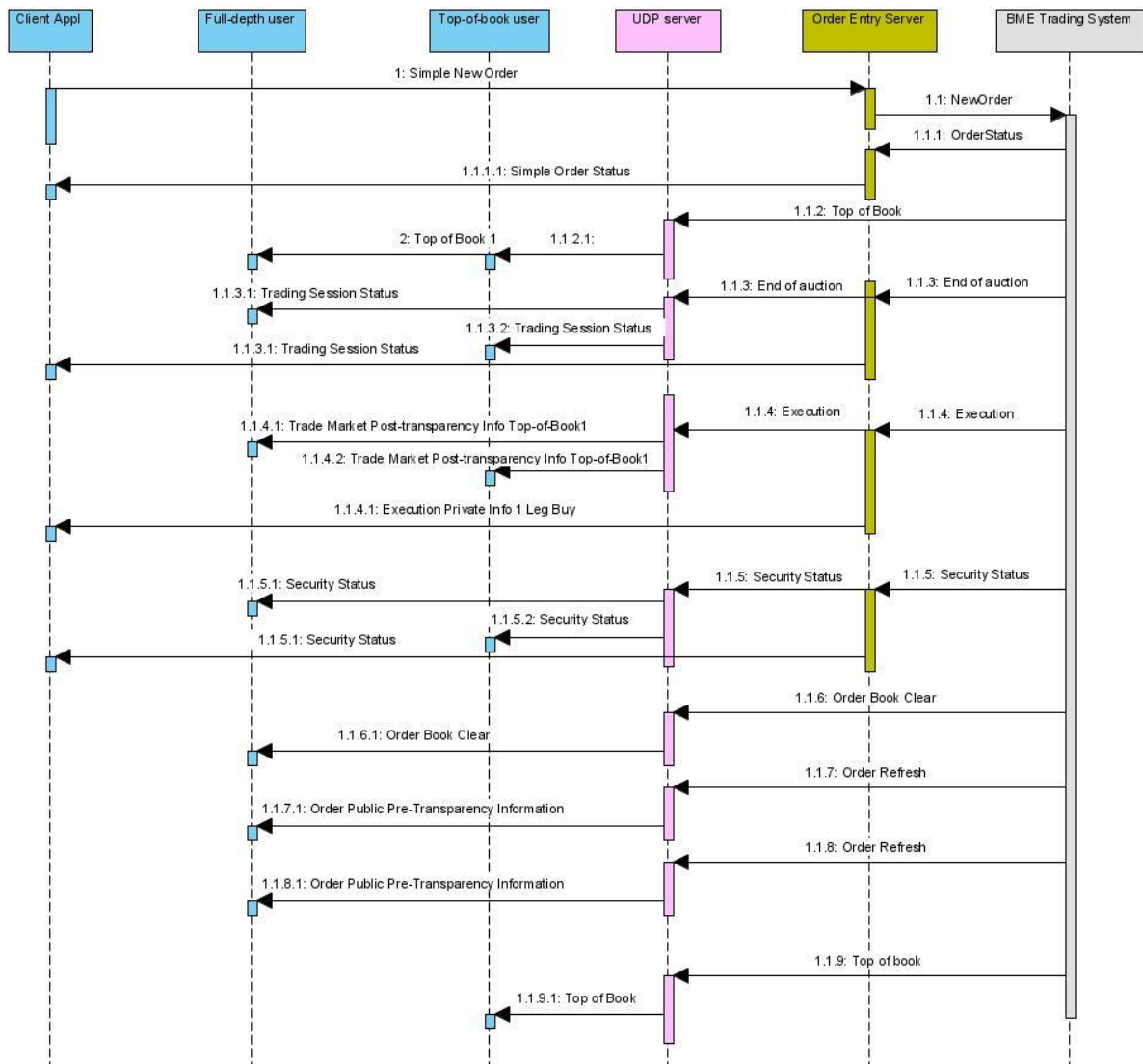

When a new auction begins, the procedure will be the converse:

- A Trading Session Status (Msg Type = 0x68) is published (in case this is an auction affecting the whole environment).
- A Security Status (MsgType = 0x66) (or Family Status (MsgType = 0x89)) message is published.
- The new situation of the book is published:
 - In the case of the C/D channels, with a Top-of-book (Msg Type = 0x82) (just one level).
 - In the case of the A/B channels, with an Order Book Clear (MsgType = 0x81) message followed by a Top-of-book (Msg Type = 0x82).

5.3.2 Treatment of aggressive orders through the “Full Depth” Market Data Feed

In order to avoid showing a crossed order book when an aggressive order arrives into the system, the following behaviour has been implemented:

1. The incoming order price is checked against current active orders of the opposite sign. If the price is compatible with a potential match, the order is just privately acknowledged to the corresponding member and is not published at this point through the Full Depth Market Data Feed.
2. If the order is matched during the transaction, partial fills distributed through the Full Depth Market Data Feed will contain information about order number and pending volume.
3. In addition, if the aggressive order is not fully matched during the transaction and remains in the book, then the order will be explicitly published/refreshed in the Full Depth feed at the end of the transaction. That is to say that an order message will be sent after the execution message in the Full Depth feed .

If the aggressive order is fully matched or fully cancelled (i.e. a non-matched IOC order, a self-match prevention mechanism cancelling the aggressive order....), and therefore doesn't remain in the book at the end of the transaction, then no messages will be sent through the Full Depth feed confirming or cancelling the order.

This behaviour allows an application reading the UDP Full Market Depth messages to base the insertion of orders in the order book just in terms of the reception of Order confirmations. The information included in the trades about pending volumes of not-yet-known orders (aggressive orders) can be ignored when building the Order Book.

Please note that in a Snapshot produced by the Recovery Server, if a trade has been published after the corresponding order status, the snapshot will not include the original order. Therefore, when processing a snapshot, information included in the trades about pending volumes of not-yet-known orders (both aggressive and non-aggressive) has to be taken into account to properly build the Order Book.

5.4 Definition of messages

The Multicast UDP Binary feeds also include some messages explained in the previous chapter as part of the session level messages. Those messages are:

- Logon Response (see section 4.3.2): It will be the first message, and will indicate the protocol version number and the HeartBeat interval used in the connection.
- Logout Response (see section (0): It will be the last message of an orderly closed connection.
- HeartBeat (see section 0): It will be used to fill gaps with no application messages.
- Network Status (see section 0): It will be used to notify network related events.

The following sections contain the definition of the rest of messages.

5.4.1 Trading Session Status (Msg Type = 0x68)

Sent by the server to inform about the session status in each Trading Mode.

Field	Type	Length	Valid values	Description
MessageSize	U	2		Length of message, including this field
MessageType	U	1		Message type
SequenceNumber	U	4		Message sequence number
TradingSessionID	U	1	See Table 25 – TradingSessionID in “BMEGate Codification Tables”	Trading mode
TradingSessionSubID	U	1	See Table 26 – TradingSessionSubID in “BMEGate Codification Tables”	Session phase
TradSesStatus	U	1	1 = Halted 2 = Open 3 = Closed 4 = Pre Open (Not started) 5 = Pre-Close 6 = Request Rejected	Trading session status
TransactionDateAndTime	T	8		Transaction Date and Time in nanoseconds since 1-jan-1970 UTC

5.4.2 Security List Cancellation Report (MsgType = 0x78)

Message sent by the server for cancelling previously defined securities.

Field	Type	Length	Valid values	Description
MessageSize	U	2		Length of message, including this field
MessageType	U	1		Message type
SequenceNumber	U	4		Message sequence number
MarketID	C	4		Operating MIC Code
MarketSegmentID	C	4		Segment MIC Code
SecurityCode	U	4		Instrument (or Book) code
Symbol	C	22		Symbol
SymbolISIN	C	12		Instrument ISIN

5.4.3 Security List (Msg Type = 0x79)

Message sent by the server to provide the definition of one security.

It shares the same layout as the Security List Update Report message, but with a different Message Type.

5.4.4 Security List Update Report (MsgType = 0x80)

Message sent by the server for reporting updates, during the session, to the security definition.

5.4.4.1 Equities

Field	Type	Length	Valid values	Description
MessageSize	U	2		Length of message, including this field
MessageType	U	1		Message type
SequenceNumber	U	4		Message sequence number
MarketID	C	4	See Table 2 – MIC Codes in “BMEGate Codification Tables”	Operating MIC Code
MarketSegmentID	C	4	See Table 2 – MIC Codes in “BMEGate Codification Tables”	Segment MIC Code
SecurityCode	U	4		Instrument (or Book) code
Symbol	C	22		Symbol
SymbolISIN	C	12		Instrument ISIN
FISN	C	35	Financial Instrument Short Name according ISO 18774	FISN
IssuerLEI	C	20		Issuer LEI
SecurityGroup	C	2	See Table 5 - Security Groups in “BMEGate Codification Tables”	Security group
CFICode	C	6		CFICode
SecurityType	C	2	See Table 6 - Security type in “BMEGate Codification Tables”	Security type
MaturityDate	D	4		Expiration date
IssueDate	D	4		Date security issued
ContractMultiplier	A	8		Conversion factor between price units and monetary units
LISpre	A	8		LIS pretransparency threshold
SSTIpre	A	8		SSTI pretransparency threshold
LISpost	A	8		LIS posttransparency threshold
SSTIpost	A	8		SSTI posttransparency threshold
LiquidInstrument	F	1		Liquid Instrument
AdmissionRequestedByIssuer	F	1		Security request for admission to trading by the issuer

Field	Type	Length	Valid values	Description
MinTradeVol	Q	4		Minimum Tradeable Volume
RoundLot	Q	4		Lot Size
Currency	C	3	According ISO 4217	Currency code
ModalityMask	B	4		Modality mask $\sum 2^{(ModalityCode - 100)}$ ModalityCode valid values are the TradingSessionID values listed in Table 25 - TradingSessionID in "BMEGate Codification Tables"
SecurityDescription	C	80		Security Description
TradingObligation	F	1		Trading obligation. Indicates whether the security has to be traded in a regulated exchange
SecurityName	C	40		Security Name
NetAssetValueIdentifier	C	7		Net Asset Value Identifier
SecuritySubType	C	2	See Table 27 – Security Subtype in "BMEGate Codification Tables"	Subtype
MaturityMonthYear	C	8		Maturity
SecurityStatus	C	1	'1' = Active '2' = Inactive (Provisionally assumed)	Security Status
StrikePrice	P	8		Exercise price. Only present for warrants
StrikeValue	A	8		Trading Unit. Number of shares for each security
ExerciseStyle	C	1	A - american E - european, B - bermudas O - others	Exercise style
PutOrCall	C	1	C - Call P - Put O - Other	Indicates whether the contract is a put or a call
PositionLimit	A	8		Capital of listed securities
NTPositionLimit	U	8		Volume of listed securities (Near Term Position Limit)
Issuer	C	12		Issuer
CPRegType	F	1		Indicates if it is an institutional security or not
Barrier	P	8		Barrier
LastTradingDay	D	4		Last Trading Day
AutomaticExpiration	F	1		Automatic Expiration

Field	Type	Length	Valid values	Description
FeeType	C	2		Fee Type
Barrier2	P	8		Second Barrier
TriggerBarrier	P	8		Trigger Lower Barrier
TriggerUpperBarrier	P	8		Trigger Upper Barrier
AverageQuarterlyTurnover	A	8		Average Quarterly Turnover
TradingScope	B	1	See Table 13 – Valid values for the Trading Scope in “BMEGate Codification Tables”	Trading Scope
SICAVCounterpartyMember	C	4		SICAV/Fund Counterparty Member
NetAssetValueIndicator	F	1		Net Asset Value Indicator
ReferenceTradingVenue	C	1	'1' Valencia '2' Bilbao '4' Barcelona '8' Madrid	Reference Trading Venue
OutstandingCapital	A	8		Outstanding Capital
FirstTradingDate	D	4		First Trading Date
SettlementSystem	C	1	See Table 16 - Settlement System in “BMEGate Codification Tables”	Settlement System
NumberOfDecimals	U	1		Number of Decimals
NumberOfHolders	U	4		Number of Holders
OutstandingShares	Q	4		Outstanding Number of Shares
MinimumAuthorizedShares	Q	4		Minimum Authorized Shares
MinimumCapital	A	8		Minimum Capital
LastAdmissionDate	D	4		Last Trading Date
BarrierReturn	P	8		Barrier Return
InvestmentFundManager	C	80		Investment Fund Manager Denomination
EffectiveAmountFiltersRoutedOrders	A	8		Effective amount for filters for routed orders
OrderNumberOfDecimals	U	1		Number of Decimals in Order Entry
InvestmentFundClass	F	1		Investment Fund Class

Field	Type	Length	Valid values	Description
MasterFundName	C	80		Master Fund Name
InvestmentFundManagementCompany	C	80		Investment Fund Management Company Name
InvestmentFundDepository	C	80		Investment Fund Depository Entity Name
InvestmentFundCategory	C	80		Investment Fund Category
InvestmentFundMinimumSubscriptionAmount	A	8		Investment Fund Minimum Subscription Amount
InvestmentFundMinimumMaintenanceAmount	A	8		Investment Fund Minimum Maintenance Amount
InvestmentFundCutOffTime	T	8		Investment Fund Cut Off Time
NAVCommunicationTerm	C	1	'1'=D+1 '2'=D+2 '3'=D+3	Net Asset Value Communication Term
InvestmentFundNumberOfDecimals	U	1		Investment Fund Number of Decimals
CommodityDerivativeIndicator	C	1	S: Commodity derivative N: Non derivative D: Derivative	Commodity Derivative Indicator
DoubleVolumeCapReached	F	1		Double Volume Cap Reached
ADT	A	8		Average Daily Turnover
BaseProduct	C	4		Base Product
SubProduct	C	4		SubProduct
FurtherSubProduct	C	4		Further SubProduct
ADNT	A	8		Average Daily Number of Trades

PriceTickRule	U	1	Rule	TICKDESC	Price Tick rules for security
			1	1/10 ^{Numdeci}	
			2	P < 50€: 1/10 ^{Numdeci} P >= 50€: 5/10 ^{Numdeci}	
			3	5/10 ^{Numdeci}	
			4	P < 10€: 1/10 ^{Numdeci} 10€ <= P > 50€: 5/10 ^{Numdeci}	

Field	Type	Length	Valid values	Description
			50€ <= P < 100€: 1/10Numdeci-1 P >= 100€: 5/10Numdeci-1	
			5	According Tick Size Table in ESMA RTS-11. Tick size depends on Average daily number of transactions (ADNT)
			6	According Tick Size Table in ESMA RTS-11. ADNT is assumed to be always 0.
			7	According Tick Size Table in ESMA RTS-11. ADNT is assumed to be always above 9000
UnderlyingSymbol	C	22		Underlying Symbol
UnderlyingISIN	C	12		Underlying ISIN Code
UnderlyingCurrency	C	3		Underlying Strike Currency
MinimumDisplayQty	Q	4		Minimum Display Volume
RetailServiceFlag	F	1		Availability of Retail Service for the security
SelfMatchPrevention	F	1		Indicates whether the security admits self-match prevention

5.4.4.2 Fixed Income

Field	Type	Length	Valid values	Description
MessageSize	U	2		Length of message, including this field
MessageType	U	1		Message type
SequenceNumber	U	4		Message sequence number
MarketID	C	4	See Table 2 – MIC Codes in “BMEGate Codification Tables”	Operating MIC Code
MarketSegmentID	C	4	See Table 2 – MIC Codes in “BMEGate Codification Tables”	Segment MIC Code
SecurityCode	U	4		Instrument (or Book) code
Symbol	C	22		Symbol
SymbolISIN	C	12		Instrument ISIN
FISN	C	35	Financial Instrument Short Name according ISO 18774	FISN
IssuerLEI	C	20		Issuer LEI
SecurityGroup	C	2	See Table 5 - Security Groups in “BMEGate Codification Tables”	Security group
CFICode	C	6		CFICode
SecurityType	C	2	See Table 6 - Security type in “BMEGate Codification Tables”	Security type
MaturityDate	D	4		Expiration date
IssueDate	D	4		Date security issued
ContractMultiplier	A	8		Conversion factor between price units and monetary units
LISpre	A	8		LIS pretransparency threshold
SSTIpre	A	8		SSTI pretransparency threshold
LISpost	A	8		LIS posttransparency threshold
SSTIpost	A	8		SSTI posttransparency threshold
LiquidInstrument	F	1		Liquid Instrument
AdmissionRequestedByIssuer	F	1		Security request for admission to trading by the issuer
MinTradeVol	Q	4		Minimum Tradeable Volume
RoundLot	Q	4		Lot Size
Currency	C	3	According ISO 4217	Currency code
				Modality mask
ModalityMask	B	4		$\sum 2^{(ModalityCode - 100)}$ ModalityCode valid values are the TradingSessionID values listed in Table 25 -

Field	Type	Length	Valid values	Description
				TradingSessionID in "BMEGate Codification Tables"
SecurityDescription	C	80		Security Description
TradingObligation	F	1		Trading obligation. Indicates whether the security has to be traded in a regulated exchange
SecurityName	C	40		Security Name
SecurityStatus	C	1	'1' = Active '2' = Inactive (Provisionally assumed)	Security Status
CouponPaymentDate	D	4		Coupon Payment Date
MinPriceIncrement	P	8		Minimum Price Increment
NumberOfDecimals	U	1		Number of Decimals
OrderNumberOfDecimals	U	1		Number of Decimals in Order Entry
CouponRate	R	8		Coupon Rate
Issuer	C	12		Issuer
TradingScope	B	1	See Table 13 - Valid values for the Trading Scope in "BMEGate Codification Tables"	Trading Scope
FirstTradingDate	D	4		First Trading Date
SettlementSystem	C	1	See Table 16 - Settlement System in "BMEGate Codification Tables"	Settlement System
Maturity	P	8		Maturity Price
CouponPeriodicity	U	1		Coupon Periodicity in Number of Months
Benchmark	F	1		Benchmark
Strippable	F	1		Strippable
VolumeIssued	A	8		Volume Issued
AliveVolume	A	8		Alive Volume
CouponType	C	1	F - Fixed V - Variable ' ' - N/A	Coupon Type
CouponQuotation	F	1		Coupon Quotation
AccruedInterestCalculationProcedure	C	1	'1' = Real base	Accrued Interest Calculation Procedure
NextRedemptionDate	D	4		Next Redemption Date

Field	Type	Length	Valid values	Description
TypeOfRedemption	C	2	RN = Nominal reduction UN = Redemption at maturity VE = Call redemption VT = Put redemption VL = Call and Put redemptions	Type Of Redemption
Facial	R	8		Facial
CalculationMethod	C	1	'0' - 30/360 (US-NASD) '1' - Actual/Actual '2' - Actual/360 '3' - Actual/365 '4' - 30/360 (European) '5' - If days to maturity <=365: Actual/360 else Actual/365	Calculation Method
DateLastCouponWasPaid	D	4		Date Last Coupon Was Paid
BondSeniority	C	4	SNDB: senior MZZD: mezzanine SBOD: subordinated JUND: junior	Bond Seniority
InterestAccrualDate	D	4		Start date for the coupon yield
StartDate	D	4		Value date
PriceType	C	1	'1'=Price '2'=Rate	Price Type
SpreadToIndex	R	8		Spread To Index
BenchmarkCurvePointsUnits	C	4	DAYS WEEK MNTH YEAR	Benchmark Curve Point for Index term. Units
BenchmarkCurvePointsValue	U	1		Benchmark Curve Point for Index term. Number of units
BenchmarkSecurityID	C	25		Benchmark Security ID
AccruedInterestRate	R	8		Accrued Interest Rate

5.4.4.3 Derivatives

Field	Type	Length	Valid values	Description
MessageSize	U	2		Length of message, including this field
MessageType	U	1		Message type
SequenceNumber	U	4		Message sequence number
MarketID	C	4	See Table 2 – MIC Codes in “BMEGate Codification Tables”	Operating MIC Code
MarketSegmentID	C	4	See Table 2 – MIC Codes in “BMEGate Codification Tables”	Segment MIC Code
SecurityCode	U	4		Instrument (or Book) code
Symbol	C	22		Symbol
SymbolISIN	C	12		Instrument ISIN
FISN	C	35	Financial Instrument Short Name according ISO 18774	FISN
IssuerLEI	C	20		Issuer LEI
SecurityGroup	C	2	See Table 5 - Security Groups in “BMEGate Codification Tables”	Underlying code
FamilyCode	C	5	See Table 8 – Product families in “BMEGate Codification Tables”	Family of instruments code
CFICode	C	6	See Table 10 – CFICode in “BMEGate Codification Tables”	CFICode
SecurityType	C	2	See Table 6 - Security type in “BMEGate Codification Tables”	Security type
MaturityDate	D	4		Expiration date
IssueDate	D	4		Date security issued
ContractMultiplier	A	8		Conversion factor between price units and monetary units
LISpre	A	8		LIS pretransparency threshold
SSTIpre	A	8		SSTI pretransparency threshold
LISpost	A	8		LIS posttransparency threshold
SSTIpost	A	8		SSTI posttransparency threshold
LiquidInstrument	F	1		Liquid Instrument
AdmissionRequestedByIssuer	F	1		Security request for admission to trading by the issuer
MinTradeVolume	Q	4		Minimum Tradeable Volume
RoundLot	Q	4		Lot Size
Currency	C	3	According ISO 4217	Currency code

Field	Type	Length	Valid values	Description
ModalityMask	B	4		Modality mask $\sum 2^{(ModalityCode - 100)}$ ModalityCode valid values are the TradingSessionID values listed in Table 25 - TradingSessionID in "BMEGate Codification Tables"
SecurityDescription	C	80		Security Description
TradingObligation	F	1		Trading obligation. Indicates whether the security has to be traded in a regulated exchange
SecDescription	C	20		Underlying security description
Underlying Asset	C	22		Underlying Asset
SecuritySubType	C	12	See Table 9 – Type of strategy in "BMEGate Codification Tables"	Strategy type
MaturityMonthYear	C	8		Maturity
StrikePrice	P	8		Exercise price. Only present for warrants
StrikeValue	A	8		Trading Unit. Number of shares for each security
OptAttribute	C	1		Security version number, provided to support versioning of securities as a result of corporate actions or events
MinPriceIncrement	P	8		Minimum Price Increment
UnitOfMeasure	C	20		Unif of Measure
SettlMethod	C	1	C - Cash P - Physical	Settlement Method
ExerciseStyle	C	1	A - American E - European V - European Automatic	Exercise Style (Options)
PutOrCall	C	1	C – Call P – Put O – Other	Indicates whether the contract is a put or a call
FlexibleIndicator	C	1	Y – Flexible N – Standard	Flexible Expiry Indicator
LastTradingDay	D	4		Last Trading Day
NumberOfDecimals	U	1		Number of Decimals
OrderNumberOfDecimals	U	1		Number of Decimals in Order Entry

Field	Type	Length	Valid values	Description
AdjustmentRule	C	1	E - Extraordinary dividend adjustments only T - Total	Adjustments rule
MaximumOrderSize	A	8		Nominal limit cap above which orders are not permitted
SelfMatchPrevention	F	1		Indicates whether the security admits self-match prevention
CommodityDerivativeIndicator	C	1	S: Commodity derivative N: Non derivative D: Derivative	Commodity Derivative Indicator
StockWhenUnderlyingIsDividend	C	22		Stock when Underlying is a Dividend
BaseProduct	C	4		Base Product
SubProduct	C	4		SubProduct
FurtherSubProduct	C	4		Further SubProduct
BaseCurrency	C	3		Base currency
QuotedCurrency	C	3		Quoted currency
MaturityMonthYearIncrementUnits	C	1	'0' = Months '1' = Days '2' = Weeks '3' = Years	MaturityMonthYear Increment Units
StartMaturityMonthYear	C	8		Maturity Interval Initial Date
EndMaturityMonthYear	C	8		Maturity Interval End Date
MaturityMonthYearIncrement	U	1		Number of MaturityMonthYear Increment Units
UnderlyingSymbol	C	22		Underlying Symbol
UnderlyingISIN	C	12		Underlying ISIN Code
UnderlyingCurrency	C	3		Underlying Strike Currency
UnderlyingSecurityIssuerLEI	C	20		Underlying Security Issuer LEI
xRollingClosingType	C	1	M: Market (Default value). Value to be used in FLEX xRolling with a closed expiry date and no possibility to modify it. 1: By buyer 2: By seller	xRolling Closing Type

Field	Type	Length	Valid values	Description
			A: By both	
xRollingReferenceBuyerRate	C	1	S: €STR (Default value for non-FLEX xRolling) F: FISAnalytics M: MEFF rate 0: Zero '': N/A (used in FLEX, in the financing leg)	xRolling reference financing buyer rate
xRollingBuyerMarkup	R	8	De -100.0000% a 100.0000%	xRolling buyer rate markup
xRollingReferenceSellerRate	C	1	S: €STR F: FISAnalytics M: MEFF rate (default value for non-FLEX xRolling) 0: Cero '': N/A (used in FLEX, in the financing leg)	xRolling reference financing seller rate
xRollingSellerMarkup	R	8	De -100.0000% a 100.0000%	xRolling reference financing seller rate
xRollingDividendPercentage	R	8	0.00-100.00	xRolling Dividend payment percentage
xRollingDividendPaymentDateDiff	U	2	0-999	xRolling Dividend Payment Date difference
LegSymbol1	C	22		Symbol in strategy or time spread
LegRatioQty1	Q	4		Ratio in strategy or time spread
LegSide1	C	1	'1' - Buy '2' - Sell	Side in strategy or time spread
LegPrice1	P	8		Price in strategy or time spread
LegSymbol2	C	22		Symbol in strategy or time spread
LegRatioQty2	Q	4		Ratio in strategy or time spread
LegSide2	C	1	'1' - Buy '2' - Sell	Side in strategy or time spread
LegPrice2	P	8		Price in strategy or time spread
LegSymbol3	C	22		Symbol in strategy or time spread
LegRatioQty3	Q	4		Ratio in strategy or time spread
LegSide3	C	1	'1' - Buy '2' - Sell	Side in strategy or time spread
LegPrice3	P	8		Price in strategy or time spread

Field	Type	Length	Valid values	Description
LegSymbol4	C	22		Symbol in strategy or time spread
LegRatioQty4	Q	4		Ratio in strategy or time spread
LegSide4	C	1	'1' - Buy '2' - Sell	Side in strategy or time spread
LegPrice4	P	8		Price in strategy or time spread
LegSymbol5	C	22		Symbol in strategy or time spread
LegRatioQty5	Q	4		Ratio in strategy or time spread
LegSide5	C	1	'1' - Buy '2' - Sell	Side in strategy or time spread
LegPrice5	P	8		Price in strategy or time spread

5.4.5 Security Status (MsgType = 0x66)

Message sent by the server to inform on the status of one security.

Field	Type	Length	Valid values	Description	R F	R V	D E
MessageSize	U	2		Length of message, including this field	x	x	x
MessageType	U	1		Message type	x	x	x
SequenceNumber	U	4		Message sequence number	x	x	x
SecurityCode	U	4		Instrument (or Book) code	x	x	x
TransactionDateAndTime	T	8		Transaction Date and Time in nanoseconds since 1-jan-1970 UTC	x	x	x
ReferencePrice	P	8		Reference price	x	x	
StaticPrice	P	8				x	
DynamicPriceOscillationPercentage	R	8		Percentage of dynamic range		x	
DynamicRangeMultiplier	U	1				x	
AuctionTriggerPrice	P	8				x	
AuctionEndTime	T	8		Actual UTC time for the end of the auction		x	
LiquidativeValueDate	D	4		Date of the Net Asset Value		x	
BonusWarrantsWithActiveBonus	F	1		Indicates whether the bonus is active or not (bonus)		x	
SecurityTradingStatus	U	1	17 = Ready to trade 18 = Not available for trading 19 = Not Traded on this Segment 20 = Unknown or Invalid 21 = Pre Open 26 = Post-close (Ready to trade in TAL)	Security Trading Status	x	x	x
AuctionOrigin	U	1	0 = No auction 100 = Manual auction 101 = Opening auction is extended 102 = Closing auction is extended 103 = Volatility auction 200 = Other	Auction type		x	
NonAvailabilityReason	U	1	0 = Not halted 100 = Halted by Regulator 101 = Halted by Market Surveillance 102 = Knock-out 103 = Knock-in pending	Reason security halted	x	x	x

Field	Type	Length	Valid values	Description	R F	R V	D E
ExemptionSituation	C	1	'0' = Specialist/s non exempted '1' = Specialist/s exempted in the buy side '2' = Specialist/s exempted in the sell side '3' = Specialist/s exempted in both sides (buy and sell)	Type of exemption			x
BlockOscillationPercentage	R	8		Price fluctuation on bid/ask spread midpoint for agreed blocks			x
HighLimitPrice	P	8		High limit price	x	x	x
LowLimitPrice	P	8		Low limit price	x	x	x
LiquidativeValue	P	8		Net Asset Value			x
StaticRangeType	C	1	P - Percentage T - Price	Static range type	x	x	
OrderStaticRange	P	8		Percentage of static range	x	x	
BlockStaticRange	P	8		Static range for parametrised blocks	x		X

5.4.6 Family Status (MsgType = 0x89)

Message sent by the server in the Derivatives environment to inform about the status a Family of products.

Field	Type	Length	Valid values	Description
MessageSize	U	2		Length of message, including this field
MessageType	U	1		Message type
SequenceNumber	U	4		Message sequence number
SecurityGroup	C	2		Underlying code (derivatives)
FamilyCode	C	5		Family of instruments code (derivatives)
TransactionDateAndTime	T	8		Transaction Date and Time in nanoseconds since 1-jan-1970 UTC
SecurityTradingStatus	U	1	17 = Ready to trade 18 = Not available for trading 20 = Unknown or Invalid 21 = Pre Open 23 = Fast Market 100 = Extraordinary Market Conditions	Security Trading Status
NonAvailabilityReason	U	1	0 = Not halted 100 = Halted by Regulator 101 = Halted by Market Surveillance 102 = Knock-out 103 = Knock-in pending	Reason security halted

5.4.7 Order Book Clear (MsgType = 0x81)

Message sent by the UDP full-depth server whenever the information about order prices must be reset. In particular, it is sent by the server when the trading mode changes from auction to open market and vice versa. During auctions, only the Top-of-book message is used. Whereas during open market, the client application can build top-of-book based on the information about all active orders Order Market Pre-Transparency Information (Msg Type = 0x03).

Field	Type	Length	Description
MessageSize	U	2	Length of message, including this field
MessageType	U	1	Message type
SequenceNumber	U	4	Message sequence number
SecurityCode	U	4	Instrument (or Book) code
TransactionDateAndTime	T	8	Transaction Date and Time in nanoseconds since 1-jan-1970 UTC

5.4.8 Top-of-book (Msg Type = 0x82)

Used by the UDP Servers to communicate Top-of-book price information during auctions. When there is an indicative match price, the fields BidPx1 and AskPx1 will have the same value.

Used also by the UDP first level top-of-book Servers to communicate Top-of-book price information during open market.

At any time, having a volume 0, implies that there are no bids or offers to be published. In that case the corresponding price will also be published as 0.

A price equals to -9223372036854775808 (0x8000000000000000) is used to notify the volume corresponding to Market orders.

This message is sent through the UDP channels C/D. Prices corresponding to orders only for retailers – indicated in this way by the Capacity Indicator in the order’s client data parameters-, coming from Retail Service Specialists, are not included in this message.

Field	Type	Length	Description	R F	R V	D E
MessageSize	U	2	Length of message, including this field	x	x	x
MessageType	U	1	Message type	x	x	x
SequenceNumber	U	4	Message sequence number	x	x	x
SecurityCode	U	4	Instrument (or Book) code	x	x	x
TransactionDateAndTime	T	8	Transaction Date and Time in nanoseconds since 1-jan-1970 UTC	x	x	x
BidOrders1	U	2	Buy number of orders	x	x	x
BidSize1	Q	4	Buy volume	x	x	x
BidPx1	P	8	Buy price	x	x	x
AltBidPx1	P	8	Alternate buy price 1	x		
RetailCIBidFlag1	F	1	The price is retail or has part of retail			x
AskOrders1	U	2	Sell number of orders	x	x	x
AskSize1	Q	4	Sell volume	x	x	x
AskPx1	P	8	Sell price	x	x	x
AltSellPx1	P	8	Alternate sell price 1	x		
RetailCIAskFlag1	F	1	The price is retail or has part of retail			x

5.4.9 Top-of-book Retail (Msg Type = 0x91)

Specific message for the Retail Service. This message is sent through the UDP channels G/H.

Best prices for retailers are provided. Values of fields BidOrders1/AskOrders1 and BidSize1/AskSize1 include orders and volumes both for retailers and general orders.

Field	Type	Length	Description	R F	R V	D E
MessageSize	U	2	Length of message, including this field	x	x	x
MessageType	U	1	Message type	x	x	x
SequenceNumber	U	4	Message sequence number	x	x	x
SecurityCode	U	4	Instrument (or Book) code	x	x	x
TransactionDateAndTime	T	8	Transaction Date and Time in nanoseconds since 1-jan-1970 UTC	x	x	x
BidOrders1	U	2	Buy number of orders	x	x	x
BidSize1	Q	4	Buy volume	x	x	x
BidPx1	P	8	Buy price	x	x	x
AltBidPx1	P	8	Alternate buy price 1	x		
AskOrders1	U	2	Sell number of orders	x	x	x
AskSize1	Q	4	Sell volume	x	x	x
AskPx1	P	8	Sell price	x	x	x
AltSellPx1	P	8	Alternate sell price 1	x		

5.4.10 Top-of-book 5 levels (Msg Type = 0x83)

Used by the UDP 5 level top-of-book Servers to communicate Top-of-book price information during open market. During auctions, only the first level is shown, and therefore this message is not published, and the message Top-of-book (Msg Type = 0x82) is used instead.

At any time, having a volume 0, implies that there's no bids or offers to be published. In that case the corresponding price will also be published as 0.

A price equals to -9223372036854775808 (0x8000000000000000) is used to notify the volume corresponding to Market orders.

This message is sent through the UDP channels E/F. Prices corresponding to orders only for retailers - indicated in this way by the Capacity Indicator in the order's client data parameters-, coming from Retail Service Specialists, are not included in this message.

Field	Type	Length	Description	R F	R V	D E
MessageSize	U	2	Length of message, including this field	x	x	x
MessageType	U	1	Message type	x	x	x
SequenceNumber	U	4	Message sequence number	x	x	x
SecurityCode	U	4	Instrument (or Book) code	x	x	x
TransactionDateAndTime	T	8	Transaction Date and Time in nanoseconds since 1-jan-1970 UTC	x	x	x
BidOrders1	U	2	Buy number of orders	x	x	x
BidSize1	Q	4	Buy volume	x	x	x
BidPx1	P	8	Buy price	x	x	x
AltBidPx1	P	8	Alternate buy price 1	x		
RetailCIBidFlag1	F	1	The price is retail or has part of retail			x
AskOrders1	U	2	Sell number of orders	x	x	x
AskSize1	Q	4	Sell volume	x	x	x
AskPx1	P	8	Sell price	x	x	x
AltSellPx1	P	8	Alternate sell price 1	x		
RetailCIAskFlag1	F	1	The price is retail or has part of retail			x
BidOrders2	U	2	Buy number of orders level 2	x	x	x
BidSize2	Q	4	Buy volume level 2	x	x	x
BidPx2	P	8	Buy price level 2	x	x	x
AltBidPx2	P	8	Alternate buy price 2	x		
RetailCIBidFlag2	F	1	The price is retail or has part of retail			x
AskOrders2	U	2	Sell number of orders level 2	x	x	x
AskSize2	Q	4	Sell volume level 2	x	x	x
AskPx2	P	8	Sell price level 2	x	x	x
AltSellPx2	P	8	Alternate sell price 2	x		
RetailCIAskFlag2	F	1	The price is retail or has part of retail			x

Field	Type	Length	Description	R F	R V	D E
BidOrders3	U	2	Buy number of orders level 3	x	x	x
BidSize3	Q	4	Buy volume level 3	x	x	x
BidPx3	P	8	Buy price level 3	x	x	x
AltBidPx3	P	8	Alternate buy price 3	x		
RetailCIBidFlag3	F	1	The price is retail or has part of retail			x
AskOrders3	U	2	Sell number of orders level 3	x	x	x
AskSize3	Q	4	Sell volume level 3	x	x	x
AskPx3	P	8	Sell price level 3	x	x	x
AltSellPx3	P	8	Alternate sell price 3	x		
RetailCIAskFlag3	F	1	The price is retail or has part of retail			x
BidOrders4	U	2	Buy number of orders level 4	x	x	x
BidSize4	Q	4	Buy volume level 4	x	x	x
BidPx4	P	8	Buy price level 4	x	x	x
AltBidPx4	P	8	Alternate buy price 4	x		
RetailCIBidFlag4	F	1	The price is retail or has part of retail			x
AskOrders4	U	2	Sell number of orders level 4	x	x	x
AskSize4	Q	4	Sell volume level 4	x	x	x
AskPx4	P	8	Sell price level 4	x	x	x
AltSellPx4	P	8	Alternate sell price 4	x		
RetailCIAskFlag4	F	1	The price is retail or has part of retail			x
BidOrders5	U	2	Buy number of orders level 5	x	x	x
BidSize5	Q	4	Buy volume level 5	x	x	x
BidPx5	P	8	Buy price level 5	x	x	x
AltBidPx5	P	8	Alternate buy price 5	x		
RetailCIBidFlag5	F	1	The price is retail or has part of retail			x
AskOrders5	U	2	Sell number of orders level 5	x	x	x
AskSize5	Q	4	Sell volume level 5	x	x	x
AskPx5	P	8	Sell price level 5	x	x	x
AltSellPx5	P	8	Alternate sell price 5	x		
RetailCIAskFlag5	F	1	The price is retail or has part of retail			x

5.4.11 Top-of-book Retail 5 levels (Msg Type = 0x92)

Specific message for the Retail Service. This message is sent through the UDP channels I/J.

Sent by the server immediately after a message Top-of-book 5 levels (Msg Type = 0x83). Best 5 prices for retailers are provided. Values of fields BidOrders/AskOrders and BidSize/AskSize include orders and volumes both for retailers and general orders.

Field	Type	Length	Description	R F	R V	D E
MessageSize	U	2	Length of message, including this field	x	x	x
MessageType	U	1	Message type	x	x	x
SequenceNumber	U	4	Message sequence number	x	x	x
SecurityCode	U	4	Instrument (or Book) code	x	x	x
TransactionDateAndTime	T	8	Transaction Date and Time in nanoseconds since 1-jan-1970 UTC	x	x	x
BidOrders1	U	2	Buy number of orders	x	x	x
BidSize1	Q	4	Buy volume	x	x	x
BidPx1	P	8	Buy price	x	x	x
AltBidPx1	P	8	Alternate buy price 1	x		
AskOrders1	U	2	Sell number of orders	x	x	x
AskSize1	Q	4	Sell volume	x	x	x
AskPx1	P	8	Sell price	x	x	x
AltSellPx1	P	8	Alternate sell price 1	x		
BidOrders2	U	2	Buy number of orders level 2	x	x	x
BidSize2	Q	4	Buy volume level 2	x	x	x
BidPx2	P	8	Buy price level 2	x	x	x
AltBidPx2	P	8	Alternate buy price 2	x		
AskOrders2	U	2	Sell number of orders level 2	x	x	x
AskSize2	Q	4	Sell volume level 2	x	x	x
AskPx2	P	8	Sell price level 2	x	x	x
AltSellPx2	P	8	Alternate sell price 2	x		
BidOrders3	U	2	Buy number of orders level 3	x	x	x
BidSize3	Q	4	Buy volume level 3	x	x	x
BidPx3	P	8	Buy price level 3	x	x	x
AltBidPx3	P	8	Alternate buy price 3	x		
AskOrders3	U	2	Sell number of orders level 3	x	x	x
AskSize3	Q	4	Sell volume level 3	x	x	x
AskPx3	P	8	Sell price level 3	x	x	x
AltSellPx3	P	8	Alternate sell price 3	x		
BidOrders4	U	2	Buy number of orders level 4	x	x	x
BidSize4	Q	4	Buy volume level 4	x	x	x
BidPx4	P	8	Buy price level 4	x	x	x
AltBidPx4	P	8	Alternate buy price 4	x		

Field	Type	Length	Description	R F	R V	D E
AskOrders4	U	2	Sell number of orders level 4	x	x	x
AskSize4	Q	4	Sell volume level 4	x	x	x
AskPx4	P	8	Sell price level 4	x	x	x
AltSellPx4	P	8	Alternate sell price 4	x		
BidOrders5	U	2	Buy number of orders level 5	x	x	x
BidSize5	Q	4	Buy volume level 5	x	x	x
BidPx5	P	8	Buy price level 5	x	x	x
AltBidPx5	P	8	Alternate buy price 5	x		
AskOrders5	U	2	Sell number of orders level 5	x	x	x
AskSize5	Q	4	Sell volume level 5	x	x	x
AskPx5	P	8	Sell price level 5	x	x	x
AltSellPx5	P	8	Alternate sell price 5	x		

5.4.12 Order Market Pre-Transparency Information (Msg Type = 0x03)

Used by the Server to communicate information about all active visible orders.

During a session, any order is uniquely identified by the SecondaryOrderID. Whenever there is a change in an order, a new Order Market Pre-Transparency Information (Msg Type = 0x03) message will be received.

Field	Type	Length	Valid values	Description	R F	R V	D E
MessageSize	U	2		Length of message, including this field	x	x	x
MessageType	U	1		Message type	x	x	x
SequenceNumber	U	4		Message sequence number	x	x	x
SecurityCode	U	4		Instrument (or Book) code	x	x	x
TransactionDateAndTime	T	8		Transaction Date and Time in nanoseconds since 1-jan-1970 UTC	x	x	x
SecondaryOrderID	U	4		System Order Number	x	x	x
EntryDate	D	4		System order entry date (when System Order Number was assigned)	x	x	x
RetailFlag	F	1		Order/Quote only for retailers		x	
Side	C	1	'1' - Buy '2' - Sell	Side	x	x	x
Priority	U	4		Priority	x	x	x
Price	P	8		Limit price	x	x	x
DisplayQty	Q	4		Visible pending volume	x	x	x
AltPrice	P	8		Yield or percent of par	x		
RetailCIFlag	F	1		Retail Client Indicator			x

5.4.13 Order Cancellation Market/Member (Msg Type = 0x01)

Used by the Server to communicate information order cancellation.

The same message is used in Full-Depth data feeds (for order cancellations of any user), in the Order Entry Server (for cancellations of user orders) and in the Market & Order Server (for order cancellations of any user).

During a session, any order is uniquely identified by the SecondaryOrderID. Whenever there is an order cancellation, the Order Cancellation message will be received.

Field	Type	Length	Valid values	Description	R F	R V	D E
MessageSize	U	2		Length of message, including this field	x	x	x
MessageType	U	1		Message type	x	x	x
SequenceNumber	U	4		Message sequence number	x	x	x
SecurityCode	U	4		Instrument (or Book) code	x	x	x
TransactionDateAndTime	T	8		Transaction Date and Time in nanoseconds since 1-jan-1970 UTC	x	x	x
SecondaryOrderID	U	4		System Order Number	x	x	x
EntryDate	D	4		System order entry date (when System Order Number was assigned)	x	x	x
RetailFlag	F	1		Order/Quote only for retailers		x	

5.4.14 Quote Market Pre-Transparency Information (Msg Type = 0x07)

Used by the Server to communicate information about active quotes.

In a session, a Quote is univoquely identified by its two orders: SecurityCode and SecondaryOrderID (buy order) and SecondaryOrderID2 (sell order).

During a session, the two orders within a quote are uniquely identified by the combination of SecurityCode, EntryDate (which in this case is always the SessionDate, and therefore it is not sent) and SecondaryOrderID. Whenever there is a change in a quote order, a Quote Market Pre-Transparency Information (Msg Type = 0x07) will be received.

In this message, all fields with the suffix 2 refer to the sell order, and the ones without the suffix refer either to both legs or the buy order.

Field	Type	Length	Valid values	Description	R F	R V	D E
MessageSize	U	2		Length of message, including this field	x	x	x
MessageType	U	1		Message type	x	x	x
SequenceNumber	U	4		Message sequence number	x	x	x
SecurityCode	U	4		Instrument (or Book) code	x	x	x
TransactionDateAndTime	T	8		Transaction Date and Time in nanoseconds since 1-jan-1970 UTC	x	x	x
SecondaryOrderID	U	4		System Order Number	x	x	x
SecondaryOrderID2	U	4		System Order Number	x	x	x
RetailFlag	F	1		Order/Quote only for retailers		x	
Priority	U	4		Priority	x	x	x
Price	P	8		Limit price	x	x	x
DisplayQty	Q	4		Visible pending volume	x	x	x
AltPrice	P	8		Yield or percent of par	x		
Priority2	U	4		Priority	x	x	x
Price2	P	8		Limit price	x	x	x
DisplayQty2	Q	4		Visible pending volume	x	x	x
AltPrice2	P	8		Yield or percent of par	x		

5.4.15 Quote Cancellation Market/Member (Msg Type = 0x05)

Used by the Server to communicate information about quote cancellation.

The same message is used in Full-Depth data feeds (for quote cancellations of any user), in the Order Entry Server (for cancellations of user quotes) and in the Market & Order Server (for quote cancellations of any user).

Field	Type	Length	Valid values	Description	R F	R V	D E
MessageSize	U	2		Length of message, including this field	x	x	x
MessageType	U	1		Message type	x	x	x
SequenceNumber	U	4		Message sequence number	x	x	x
SecurityCode	U	4		Instrument (or Book) code	x	x	x
TransactionDateAndTime	T	8		Transaction Date and Time in nanoseconds since 1-jan-1970 UTC	x	x	x
SecondaryOrderID	U	4		System Order Number	x	x	x
SecondaryOrderID 2	U	4		System Order Number	x	x	x
RetailFlag	F	1		Order/Quote only for retailers		x	

5.4.16 Trade Market Post-Transparency Information Top-of-book (Msg Type = 0x10)

Used by the server to communicate trade information related to trades resulting from order matching in channels C/D and E/F. It is also used in channels A/B when the trade is the result of order matching at the end of an auction period (where only top-of-book information is shown).

Field	Type	Length	Valid values	Description	R F	R V	D E
MessageSize	U	2		Length of message, including this field	x	x	x
MessageType	U	1		Message type	x	x	x
SequenceNumber	U	4		Message sequence number	x	x	x
SecurityCode	U	4		Instrument (or Book) code	x	x	x
TransactionDateAndTime	T	8		Transaction Date and Time in nanoseconds since 1-jan-1970 UTC	x	x	x
MarketSegmentID	C	4		MIC Code	x	x	x
TradingSessionID	U	1	See Table 25 - TradingSessionID in "BMEGate Codification Tables"	Trading mode	x	x	x
TrdMatchID	U	4		System Trade Number	x	x	x
TradeType	C	1	See Table 4 - Trade types in "BMEGate Codification Tables"	Trade type	x	x	x
LastPX	P	8		Trade price	x	x	x
LastQty	Q	4		Current trade volume	x	x	x
GrossTradeAmt	A	8		Premium / Trade amount	x	x	x
Designation	C	1	'1' Trade during Open Market '2' Trade during Opening Auction '3' Trade during Closing Auction '4' Trade during volatility auction '5' Trade during manual auction '6' Trade during opening auction extension '7' Trade during closing auction extension '8' Trade during TAL period	Trade situation	x	x	x
MarketMechanism	C	1	See Table 28 - Level 1	Market Mechanism	x	x	x
AlgoFlag	F	1	Flag ALGO RTS1	Algorithmic flag indicator	x	x	x
BuyerBolsaCode	C	1	See Table 15 - Bolsa code belonging to the member (buy side) in "BMEGate Codification Tables"	Stock Exchange code of the buyer		x	
AltLastPX	P	8		Trade yield or percent of par	x		
AccruedInterestAmt	A	8		Accrued Interest amount	x		

Field	Type	Length	Valid values	Description	R F	R V	D E
AccruedInterestRate	P	8		Interest rate of coupon	x		
SettleDate	D	4		Settlement date	x	x	
TransactionCategory	C	1	See Table 28 – Level 3.1		x	x	x
StrategyTradeMatchID	U	4		System Trade Number of the time-spread or strategy			x

5.4.17 Trade Market Post-Transparency Information Full-Depth (Msg Type = 0x11)

Used by the server to communicate trade information related to trades resulting from order matching.

The message also contains the situation in which the relevant orders will remain in the books. Therefore, the client application must update order book status with this message.

In this message, all fields with the suffix 2 refer to the sell order, and the ones without the suffix refer either to both legs or the buy order.

Field	Type	Length	Valid values	Description	R F	R V	D E
MessageSize	U	2		Length of message, including this field	x	x	x
MessageType	U	1		Message type	x	x	x
Sequence Number	U	4		Message sequence number	x	x	x
SecurityCode	U	4		Instrument (or Book) code	x	x	x
TransactionDateAndTime	T	8		Transaction Date and Time in nanoseconds since 1-jan-1970 UTC	x	x	x
MarketSegmentID	C	4		MIC Code	x	x	x
TradingSessionID	U	1	See Table 25 – TradingSessionID in “BMEGate Codification Tables”	Trading mode	x	x	x
TrdMatchID	U	4		System Trade Number	x	x	x
TradeType	C	1	See Table 4 - Trade types in “BMEGate Codification Tables”	Trade type	x	x	x
LastPX	P	8		Trade price	x	x	x
LastQty	Q	4		Current trade volume	x	x	x
GrossTradeAmt	A	8		Premium / Trade amount	x	x	x
Designation	C	1	'1' Trade during Open Market '2' Trade during Opening Auction '3' Trade during Closing Auction '4' Trade during volatility auction '5' Trade during manual auction '6' Trade during opening auction extension '7' Trade during closing auction extension '8' Trade during TAL period	Trade situation	x	x	x
MarketMechanism	C	1	See Table 28 – Level 1	Market Mechanism	x	x	x
AlgoFlag	F	1	Flag ALGO RTS1	Algorithmic flag indicator	x	x	x
BuyerBolsaCode	C	1	See Table 15 - Bolsa code belonging to the member (buy side) in “BMEGate Codification Tables”	Stock Exchange code of the buyer		x	

Field	Type	Length	Valid values	Description	R F	R V	D E
AltLastPX	P	8		Trade yield or percent of par	x		
AccruedInterestAmt	A	8		Accrued Interest amount	x		
AccruedInterestRate	P	8		Interest rate of coupon	x		
SettleDate	D	4		Settlement date	x	x	
TransactionCategory	C	1	See Table 28 – Level 3.1		x	x	x
StrategyTradeMatchID	U	4		System Trade Number of the time-spread or strategy			x
SecondaryOrderID	U	4		System Order Number	x	x	x
EntryDate	D	4		System order entry date (when System Order Number was assigned)	x	x	x
Priority	U	4		Priority	x	x	x
Price	P	8		Limit price	x	x	x
DisplayQty	Q	4		Visible pending volume	x	x	x
AltPrice	P	8		Yield or percent of par	x		
RetailFlag	F	1		Order/Quote only for retailers		x	
RetailClientFlag	F	1		Retail Client Indicator			x
SecondaryOrderID2	U	4		System Order Number	x	x	x
EntryDate2	D	4		System order entry date (when System Order Number was assigned)	x	x	x
Priority2	U	4		Priority	x	x	x
Price2	P	8		Limit price	x	x	x
DisplayQty2	Q	4		Visible pending volume	x	x	x
AltPrice2	P	8		Yield or percent of par	x		
RetailFlag2	F	1		Order/Quote only for retailers		x	
RetailClientFlag2	F	1		Retail Client Indicator			x

5.4.18 Trade, Trade Amendment or Cancellation (MsgType = 0x18)

Sent by the server to inform about a trade produced due to a trade amendment, a cancellation or any reason other than order matching.

In this message, all fields with the suffix 2 refer to the sell order, and the ones without the suffix refer either to both legs or the buy order.

Field	Type	Length	Valid values	Description	R F	R V	D E
MessageSize	U	2		Length of message, including this field	x	x	x
MessageType	U	1		Message type	x	x	x
SequenceNumber	U	4		Message sequence number	x	x	x
SecurityCode	U	4		Instrument (or Book) code	x	x	x
TransactionDateAndTime	T	8		Transaction Date and Time in nanoseconds since 1-jan-1970 UTC	x	x	x
MarketSegmentID	C	4		MIC Code	x	x	x
TradingSessionID	U	1	See Table 25 – TradingSessionID in “BMEGate Codification Tables”	Trading mode	x	x	x
TrdMatchID	U	4		System Trade Number	x	x	x
TradeType	C	1	See Table 4 - Trade types in “BMEGate Codification Tables”	Trade type	x	x	x
LastPX	P	8		Trade price	x	x	x
LastQty	Q	4		Current trade volume	x	x	x
GrossTradeAmt	A	8		Premium / Trade amount	x	x	x
Designation	C	1	'1' Trade during Open Market '2' Trade during Opening Auction '3' Trade during Closing Auction '4' Trade during volatility auction '5' Trade during manual auction '6' Trade during opening auction extension '7' Trade during closing auction extension '8' Trade during TAL period	Trade situation	x	x	x
MarketMechanism	C	1	See Table 28 – Level 1	Market Mechanism	x	x	x
AlgoFlag	F	1	Flag ALGO RTS1	Algorithmic flag indicator	x	x	x
BuyerBolsaCode	C	1	See Table 15 - Bolsa code belonging to the member (buy side) in “BMEGate Codification Tables”	Stock Exchange code of the buyer		x	
AltLastPX	P	8		Trade yield or percent of par	x		

Field	Type	Length	Valid values	Description	R F	R V	D E
AccruedInterestAmt	A	8		Accrued Interest amount	x		
AccruedInterestRate	P	8		Interest rate of coupon	x		
SettleDate	D	4		Settlement date	x	x	
TransactionCategory	C	1	See Table 28 – Level 3.1		x	x	x
StrategyTradeMatchID	U	4		System Trade Number of the time-spread or strategy			x
LastChangeFlag	F	1		Indicates if this trade changes the instrument Last price	x	x	x
BENC_RFPT_Flag	C	1	See Table 28 – Levels 3.5, 3.11 and 3.12	Benchmark or Reference Price Indicator MMT	x	x	x
TradePriceCondition	C	1	See Table 28 – Level 3.8	MMT 3.8	x	x	x
PreTradeTransparencyWaiver	C	1	See Table 28 – Levels 3.2 and 3.10	Pre-trade transparency waiver	x	x	x
DeferralWaiver	C	1	See Table 28 – Levels 4.1, 4.3 and 4.4	Deferral Waiver	x	x	x
PostDeferralPublicationType	C	1	See Table 28 – Level 4.2	Post-deferral publication type	x		x
PublishDateAndTime	T	8		Publication Date and Time in nanoseconds since 1-jan-1970 UTC	x	x	x
TradeDate	T	8		Trade date and time	x	x	x
TradeSessionDate	D	4		Trade Session Date	x	x	x
SettleDate2	D	4		Settlement date of the second leg	x		
EndCash	A	8		Amount to be settled at the end of the Repo Trade	x		
VolumeFloat	V	8		Volume with decimal places			x
SICAVFundCounterpartySide	C	1	'1' = Buyer '2' = Seller ' ' = N/A	Indicates the side of the Counterparty member in a SICAV or Mutual Fund			x
AmendedTradeType	C	1	See Table 4 - Trade types in "BMEGate Codification Tables"	Trade type of the amended/cancelled trade	x	x	x
ExecRefID	U	4		System Trade Number of the amended/cancelled trade	x	x	x
AmendedTradeDate	D	4		Date of the amended/cancelled trade	x	x	x

5.4.19 Statistics (MsgType = 0x84)

Message sent by the server to inform about closing prices and other statistics.

Field	Type	Length	Valid values	Description	R F	R V	D E
MessageSize	U	2		Length of message, including this field	x	x	x
MessageType	U	1		Message type	x	x	x
SequenceNumber	U	4		Message sequence number	x	x	x
SecurityCode	U	4		Instrument (or Book) code	x	x	x
TransactionDateAndTime	T	8		Transaction Date and Time in nanoseconds since 1-jan-1970 UTC	x	x	x
DataCount	U	1		Number of data values	x	x	x
REPEATING GROUP							
DataCode	C	1	D Average Price d Previous forward price E Published cash amount e Order modality cash amount f End of session indicator G First H High h Maximum Bid I Open Interest (at closing) J Not published volume M Last N Number of trades O Open Interest (opening) Q Previous Closing Price	Data field code	x	x	x

Field	Type	Length	Valid values	Description	R F	R V	D E
				R Opening volatility V Published volume v Published volume order modality W Volume of Last trade Z Low z Minimum Ask j Closing price k Closing yield l Volatility m Delta n Forward price			
DataValue	Type	If DataCode value is ...					
	P	D Average Price d Previous forward price G First H High h Maximum Bid I Open Interest (at closing) M Last O Open Interest (opening) Q Previous Closing Price Z Low z Minimum Ask j Settlement price k Settlement yield n Forward price	8	Data field value	x	x	x
	V	J Not published volume V Published volume v Published volume order modality W Volume of Last trade					
	A	E Published cash amount e Order modality cash amount					
	R	l Volatility m Delta R Opening volatility					

Field	Type	Length	Valid values	Description	R F	R V	D E
	U			f End of session indicator (0 if not end of session) N Number of trades			

5.4.20 Indication of Interest (Msg Type = 0x36)

Used by the Server to notify an indication of interest on a specific instrument.

This functionality is available in Fixed Income and Derivatives.

In Fixed Income this message always notifies about a RFQ request.

In Derivatives the field IOIQtyInd indicates if the message refers to a RFQ request (value 'H') or to a request for orders in the instrument (value 'M').

Field	Type	Length	Valid values	Description	R	D
					F	E
MessageSize	U	2		Length of message, including this field	x	x
MessageType	U	1		Message type	x	x
SequenceNumber	U	4		Message sequence number	x	x
SecurityCode	U	4		Instrument (or Book) code	x	x
TransactionDateAndTime	T	8		Transaction Date and Time in nanoseconds since 1-jan-1970 UTC	x	x
IOIID	U	4	0	RFQ identifier	x	x
IOITransType	C	1	N = New C = Cancel R = Replace	Message type	x	x
Side	C	1	'1' = Buy '2' = Sell '7' = Undisclosed	Side	x	x
IOIQty	Q	4		Requested indicative volume	x	x
IOIPrice	P	8		Requested indicative price	x	x
IOIQtyInd	C	1	H = High (RFQ requested) M = Medium (order requested)	Request type		x
TradingSessionID	U	1	See Table 25 – TradingSessionID in “BMEGate Codification Tables”	Trading mode	x	x

5.4.21 RFQ Market Pre-Transparency information (Msg Type = 0x85)

Used by the server to communicate price information about RFQs.

The contents of the RFQID field match those of the field IOIID in the corresponding Indication of Interest message.

Field	Type	Length	Valid values	Description	R	D
					F	E
MessageSize	U	2		Length of message, including this field	x	x
MessageType	U	1		Message type	x	x
SequenceNumber	U	4		Message sequence number	x	x
RFQID	U	4		RFQ identifier	x	x
TradingSessionID	U	1	See Table 25 – TradingSessionID in “BMEGate Codification Tables”	Trading mode	x	x
SecurityCode	U	4		Instrument (or Book) code	x	x
TransactionDateAndTime	T	8		Transaction Date and Time in nanoseconds since 1-jan-1970 UTC	x	x
MidBuyPrice	P	8		Mid price of buying RFQs	x	x
MidBuyVolume	Q	4		Mid volume of buying RFQs	x	x
BuyRFQsNumber	U	2		Number of buying RFQs	x	x
MidSellPrice	P	8		Mid price of selling RFQs	x	x
MidSellVolume	Q	4		Mid volume of selling RFQs	x	x
SellRFQsNumber	U	2		Number of selling RFQs	x	x
BidOrders1	U	2		Buy number of orders	x	x
BidSize1	Q	4		Buy volume	x	x
BidPx1	P	8		Buy price	x	x
AskOrders1	U	2		Sell number of orders	x	x
AskSize1	Q	4		Sell volume	x	x
AskPx1	P	8		Sell price	x	x
BidOrders2	U	2		Buy number of orders level 2	x	x
BidSize2	Q	4		Buy volume level 2	x	x
BidPx2	P	8		Buy price level 2	x	x
AskOrders2	U	2		Sell number of orders level 2	x	x
AskSize2	Q	4		Sell volume level 2	x	x
AskPx2	P	8		Sell price level 2	x	x
BidOrders3	U	2		Buy number of orders level 3	x	x
BidSize3	Q	4		Buy volume level 3	x	x
BidPx3	P	8		Buy price level 3	x	x
AskOrders3	U	2		Sell number of orders level 3	x	x
AskSize3	Q	4		Sell volume level 3	x	x

Field	Type	Length	Valid values	Description	R	D
AskPx3	P	8		Sell price level 3	x	x
BidOrders4	U	2		Buy number of orders level 4	x	x
BidSize4	Q	4		Buy volume level 4	x	x
BidPx4	P	8		Buy price level 4	x	x
AskOrders4	U	2		Sell number of orders level 4	x	x
AskSize4	Q	4		Sell volume level 4	x	x
AskPx4	P	8		Sell price level 4	x	x
BidOrders5	U	2		Buy number of orders level 5	x	x
BidSize5	Q	4		Buy volume level 5	x	x
BidPx5	P	8		Buy price level 5	x	x
AskOrders5	U	2		Sell number of orders level 5	x	x
AskSize5	Q	4		Sell volume level 5	x	x
AskPx5	P	8		Sell price level 5	x	x

5.4.22 News (Msg Type = 0x42)

Used by the Server to communicate a Market Surveillance or system-wide text message.

Field	Type	Length	Valid values	Description
MessageSize	U	2		Length of message, including this field
MessageType	U	1		Message type
SequenceNumber	U	4		Message sequence number
NewsText	C	78		News text

6 Order Entry messages

6.1 Introduction

Private messages are the ones related to order, quote and trade management, and include the following functionalities:

Setting common order and quote attributes

Order management. Entering, modifying and cancelling orders.

Quote management. Entering, modifying and cancelling quotes (where a quote is the combination of a buy and a sell limit order on the same security).

Executions. Getting information on matched orders and quotes.

Trades not related to order matching. Getting information on other trades, not related to order matching, such as cross orders, special trades, trade cancellations and trade amendments.

6.1.1 Order Entry messages summary

The following table displays the private functions and their related messages.

Order Entry function	Related messages	Inbound / Outbound	Order entry server	Market & Order Server
Setting default order and quote parameters	Order and Quote Client Data (MsgType = 0x6F)	I	X	X
	Order and Quote Client Data Parameters Ack/Nack (MsgType = 0x87)	O	X	X
Setting derivatives delta protection parameters	Delta Protection Parameters (MsgType = 0x86)	I	X	X
	Delta Protection Parameters Ack/Nack (MsgType = 0x88)	O	X	X
Order Management	Simple new order (MsgType = 0x44)	I	X	X
	Simple new order with Client Data (MsgType = 0x45)	I	X	X
	Simple order modification (MsgType = 0x47)	I	X	X
	Simple order modification with Client Data (MsgType = 0x48)	I	X	X
	Simple Order Status (MsgType = 0x02)	O	X	X
	Order cancellation request (MsgType = 0x46)	I	X	X
	Order Cancellation Market/Member (MsgType = 0x01)	O	X	X
Quote management	Order Cancel Reject (MsgType = 0x39)	O	X	X
	New Quote (MsgType = 0x53)	I	X	X
	Quote modification request (MsgType = 0x61)	I	X	X
	Quote Status (MsgType = 0x06)	O	X	X
	Quote cancellation request (MsgType = 0x5A)	I	X	X
	Quote Cancellation Market/Member (MsgType = 0x05)	O	X	X
Mass cancellation	Mass order/quote cancellation (MsgType = 0x71)	I	X	X
	Order Cancellation Market/Member (MsgType = 0x01)	O	X	X
	Quote Cancellation Market/Member (MsgType = 0x05)	O	X	X
	Mass order/quote cancellation completion (MsgType = 0x72)	O	X	X
	Mass order/quote cancellation reject (MsgType = 0x73)	O	X	X
Trade due to Order Matching	Execution Private Information 1 Leg Buy (Order Entry) (MsgType = 0x12)	O	X	
	Execution Private Information 1 Leg Buy (Market & Order) (MsgType = 0x13)	O		X

Order Entry function	Related messages	Inbound / Outbound	Order entry server	Market & Order Server
	Execution Private Information 1 Leg Sell (Order Entry) (MsgType = 0x14)	O	X	
	Execution Private Information 1 Leg Sell (Market & Order) (MsgType = 0x15)	O		X
	Execution Private Information 2 Legs (MsgType = 0x17)	O	X	X
Trade due to reasons other than Order Matching	Trade, Trade Amendment or Cancellation 1 Leg Buy Private Information (MsgType = 0x1A)	O	X	X
	Trade, Trade Amendment or Cancellation 1 Leg Sell Private Information (MsgType = 0x1C)	O	X	X
	Trade, Trade Amendment or Cancellation 2 Legs Private Information (MsgType = 0x1E)	O	X	X

6.2 Some scenarios

6.2.1 Order and quote client data parameters

This functionality allows the client to define up to 65535 combinations of client attributes that will be used for subsequent orders and quotes sent during the date session through this connection. No persistence between sessions of this information is performed by the system.

The client application sends an Order and Quote Client Data (MsgType = 0x6F) message, and the server responds with an Order and Quote Client Data Parameters Ack/Nack (MsgType = 0x87) message.

6.2.2 Derivatives delta protection parameters

In the Derivatives environment a client application can activate this protection for its quotes and orders, within an underlying asset and contract type, as follows:

- Time period considered for delta protection (between 1 and 60 seconds)
- Total volume of traded contracts

If the trader is not interested in delta protection, "period of time for delta protection" parameter can be configured with a zero value.

After each trade, a check is performed to ascertain if the aggregated volume on 'M' type trades during the last n seconds (as defined in the corresponding parameter) for the trader, underlying asset, contract type and account equals or exceeds the one defined in the delta protection.

Once the delta protection filter has been triggered, the delta protection parameters are deactivated and all trader's pending orders and quotes on this underlying asset, contract type and account are cancelled.

In order to protect from executions on the fly, no new orders or no new quotes on this underlying asset and contract type will be admitted until the client application sends a new Delta Protection Parameters message, reactivating the limits. Sending this message implies setting to zero the trade volume counters in the corresponding underlying asset and contract type.

It must be taken into account that during auction resolution the delta protection feature doesn't apply.

6.2.3 Order management

Five different types of message can be sent by the client application: Simple new order (MsgType = 0x44), Simple new order with Client Data (MsgType = 0x45), Simple order modification (MsgType = 0x47), Simple order modification with Client Data (MsgType = 0x48) and Order cancellation request (MsgType = 0x46).

If the order is matched, either partially or completely, a Simple new order (MsgType = 0x44) message will always precede an Execution Private Information 1 Leg Sell (Order Entry) (MsgType = 0x14), Execution Private Information 1 Leg Buy (Market & Order) (MsgType = 0x13), Execution Private Information 1 Leg Sell (Market & Order) (MsgType = 0x15) or Execution Private Information 2 Legs (MsgType = 0x17) (see 6.2.6).

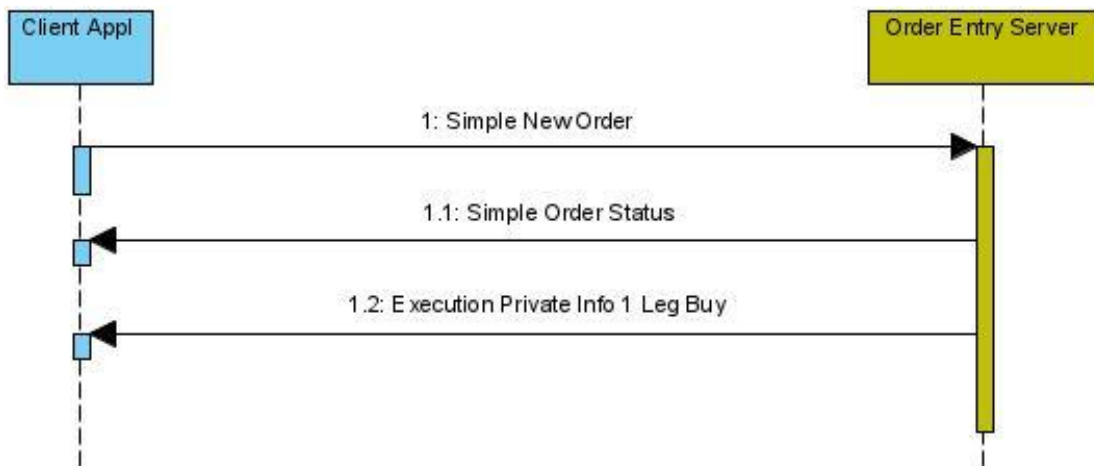

If the order is not matched, a Simple Order Status (MsgType = 0x02) message will be sent. This same message will be used to notify the result of order modifications. When the order is cancelled, the Order Cancellation Market/Member (Msg Type = 0x01) is sent (see 0).

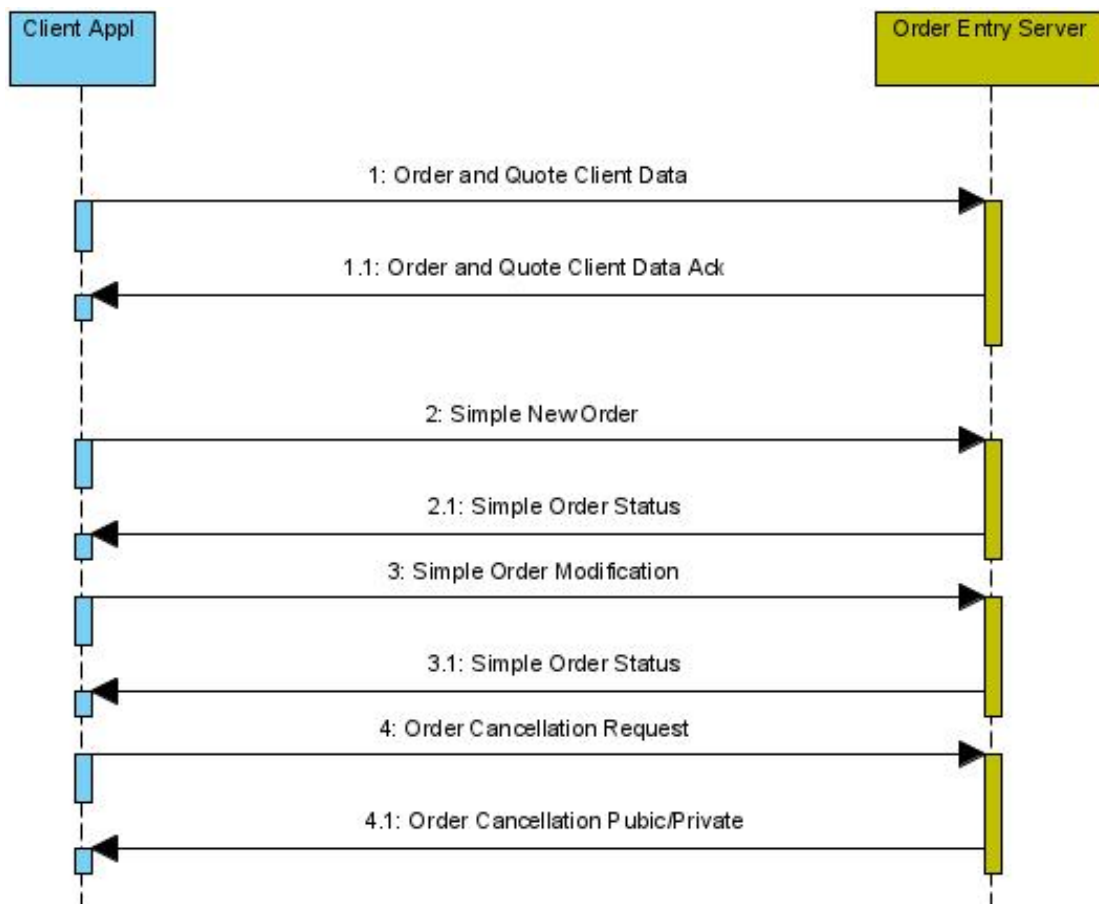

6.2.4 Quote management

Three different types of message can be sent by the client application: New Quote (MsgType = 0x53), Quote modification request (MsgType = 0x61) and Quote cancellation request (MsgType = 0x5A). The answer can be a Quote Status (MsgType = 0x06) message or a Quote Cancellation Market/Member (Msg Type = 0x05) message. For each Trade, an Execution Private Information message will be sent.

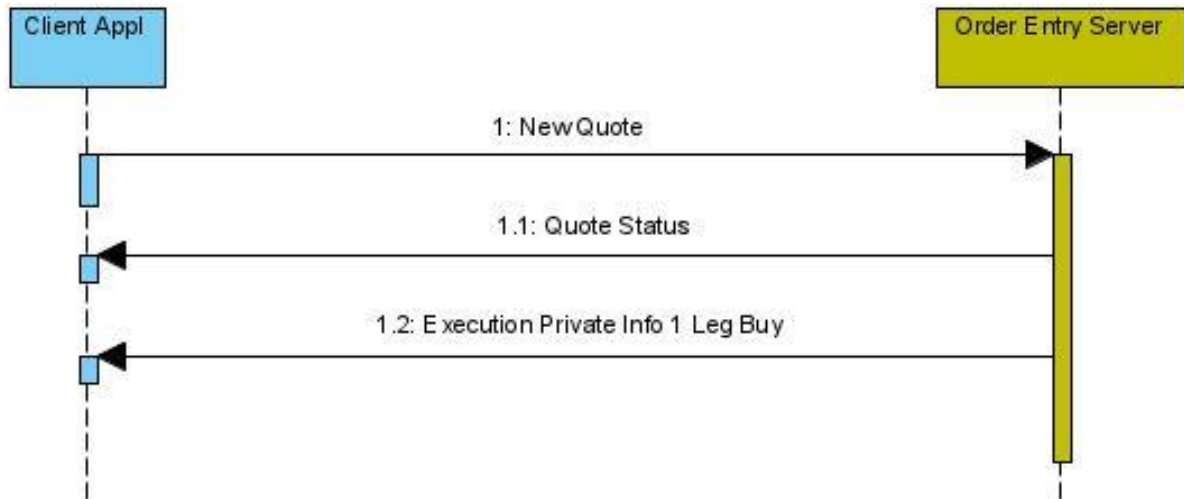

It is possible to use the Quote messages even if only one of the sides is used, by setting the volume of the other side to zero.

In Equities and Derivatives a new quote will replace any pre-existing quote on the same security sent by the same user. Please, bear in mind that the rejection of the new quote by a Quote Status message - field ExecType is to be 8 (Rejection)- involves the implicit cancellation of the pre-existing quote.

In Fixed Income, depending on the Regulations, it may apply a restriction whereby a single Quote per member and security is allowed. Or it may even be allowed to have several live quotes on the same security (the ClientDataID field would be used to distinguish them).

6.2.5 Mass cancellation

The client can use the Mass order/quote cancellation (MsgType = 0x71) message to cancel with a single instruction a complete set of orders and/or quotes based on several selection criteria. As an immediate answer, Order Entry Server will send a message Order Mass Cancel Report (MsgType = 0x72). In addition, if there's something to cancel, the system will answer with the corresponding Order Cancellation Market/Member (Msg Type = 0x01) and/or Quote Cancellation Market/Member (Msg Type = 0x05) messages.

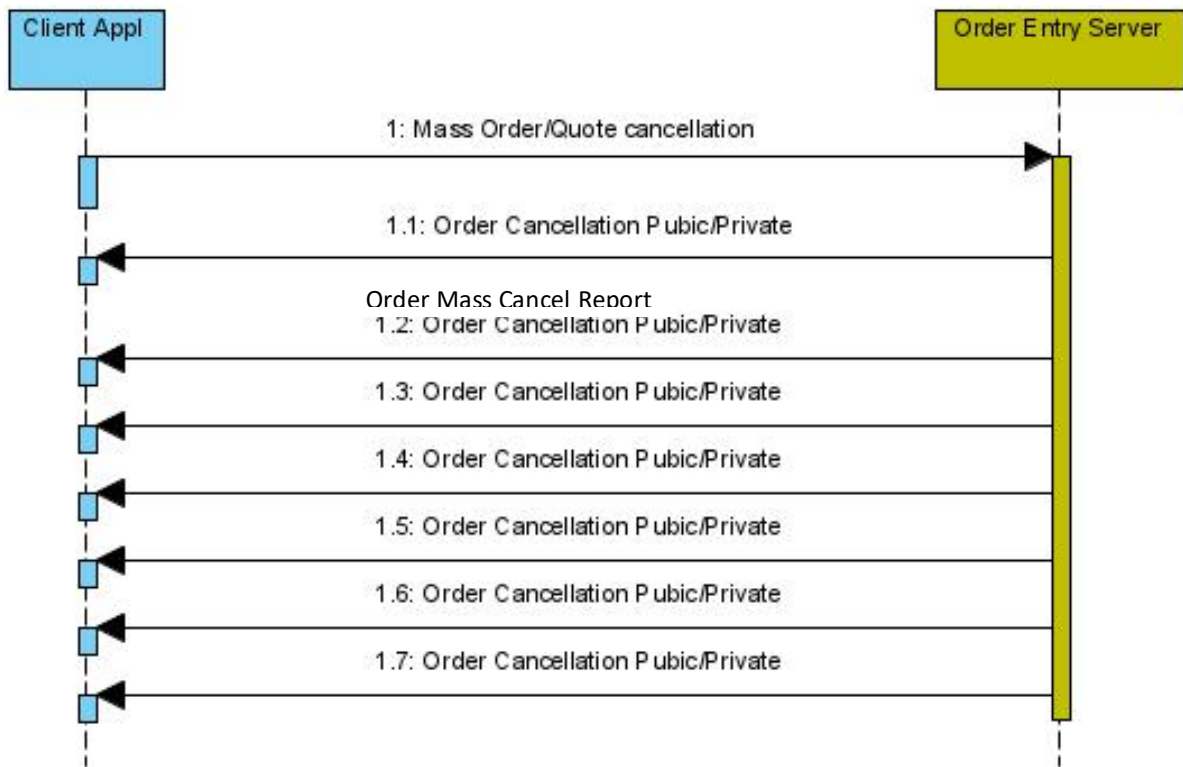

6.2.6 Trades due to order matching

There are different types of Execution notifications, depending on the number of legs belonging to the user in the execution (so that if the two legs correspond to orders or quotes entered by the same user, a single message will contain the whole information about both legs).

Also, in 1 Leg executions notified by a Market & Order server, there will be some basic information about the order of the counterparty, so that the application can update the order books.

6.2.7 Other trades (not the result of order matching)

Trades can also be the result of Special Trades, cross trades, cancellations, amendments...

Again, there are different types of Trade notifications, depending on the number of legs belonging to the user (so that if the two legs correspond to the same user, a single message will contain the whole information about both legs).

6.3 Definition of inbound messages

6.3.1 Order and Quote Client Data (MsgType = 0x6F)

Sent by the client to set default attributes for subsequent orders and quotes.

Please note that in Fixed Income it is possible to enter orders on behalf of other members (AccountMember), based on the corresponding brokerage permissions.

If at any time a ClientDataID attributes are modified, the changes will only affect the subsequent new orders or quotes, never the pending orders or quotes using this ClientDataID.

Field	Type	Length	Valid values	Description	R F	R V	D E
MessageSize	U	2		Length of message, including this field	x	x	x
MessageType	U	1		Message type	x	x	x
RequestID	U	4		Request ID (for application feedback)	x	x	x
ClientDataID	U	2	1-65535 (in response messages, 0 means no ClientDataID used)	Client Data ID (to be used as a shortcode in orders and quotes)	x	x	x
AlgorithmicTradeIndicator	F	1		Algorithmic flag indicator	x	x	x
ClientID	U	4		Mifid II ClientID	x	x	x
AccountBolsa	C	16		Client code	x	x	
Account	C	5		Account	x	x	x
DEAFlag	F	1		Direct Electronic Access indicator	x	x	x
DecisorID	U	4		MIFID II DecisorID	x	x	x
ExecutorID	U	4		Mifid II ExecutorID	x	x	x
LiquidityProvisionActivity	F	1		Liquidity Provision Activity Flag	x	x	x
GiveInMember	C	4		Give-in member		x	x
AccountMember	C	4			x		
FirmMnemonic	C	10				x	x
AllocText	C	18				x	x
LastCapacity	C	1	D=Dealing on own account M=Matched principal A=Any Other Trading Capacity blanco		x	x	x
SelfMatchPreventionID	U	2				x	x
AutomaticOrderFilterFlag	C	1	2 - For orders entered by an authorized trader g - For authorized arbitration orders			x	

Field	Type	Length	Valid values	Description	R F	R V	D E
			C - For orders not entered by an authorized trader ' ' - N/A				
ReceivedDept ID	C	1	I = Orders placed through the Internet B = Orders placed through the bank branch network T = Orders placed through automatic trading systems C = Orders placed by important clients O = Others ' ' = N/A (Workstation)				x
Persistence	C	1	C - Cancel on disconnection P - Persist on disconnection	Persistence type	x	x	x
AccountType	C	1	9 = Retail Service Specialist 8 = Retail customer (Supported for compatibility): A = On behalf of third parties P = House trader E = Specialist	Capacity Indicator			x
SelfMatchPreventionType	C	1	' ' = N/A or default behaviour (aggressive order is rejected) 1 = Reject aggressive order 2 = Cancel pasive order 3 = Cancel both passive and aggressive order				x x
ClientDataReference	C	15		Free to use by clients	x	x	x

6.3.2 Delta Protection Parameters (MsgType = 0x86)

Sent by the client in Derivatives to set attributes for delta protection.

Field	Type	Length	Valid values	Description	DE
MessageSize	U	2		Length of message, including this field	x
MessageType	U	1		Message type	x
RequestID	U	4		Request ID (for application feedback)	x
SecurityGroup	C	2	See Table 5 - Security Groups in "BMEGate Codification Tables"	Underlying code	x
ProductType	C	1	F Future O Option	Derivative type	x
DeltaProtectionTime	U	1	0-60	Number of seconds for Delta Protection control	x
DeltaProtectionVolume	Q	4		Total maximum volume during DeltaProtectionTime	x

6.3.3 Simple new order (MsgType = 0x44)

Message sent by the client to enter a new order.

Field	Type	Length	Valid values	Description	R F	R V	D E
MessageSize	U	2		Length of message, including this field	x	x	x
MessageType	U	1		Message type	x	x	x
RequestID	U	4		Request ID (for application feedback)	x	x	x
SecurityCode	U	4		Instrument (or Book) code	x	x	x
ClientDataID	U	2	1-65535 (in response messages, 0 means no ClientDataID used)	Client Data ID (to be used as a shortcode in orders and quotes)	x	x	x
OrderID	U	4		Application Order ID (unique at security level)	x	x	x
Side	C	1	'1' - Buy '2' - Sell	Side	x	x	x
Price	P	8		Limit price	x	x	x
OrderQuantity	Q	4		Total order volume	x	x	x
TimeInForce	C	1	See Table 3 - Order Types in "BMEGate Codification Tables"	GTD orders are not supported	x	x	x

6.3.4 Simple new order with Client Data (MsgType = 0x45)

Message sent by the client to enter a new order and, at the same time, the values for the Client Data parameters. Note that no ClientDataID may be assigned. It will be answered by a message Simple Order Status (MsgType = 0x02) where the value of ClientDataID field will be set to zero.

Field	Type	Length	Valid values	Description	R F	R V	D E
MessageSize	U	2		Length of message, including this field	x	x	x
MessageType	U	1		Message type	x	x	x
RequestID	U	4		Request ID (for application feedback)	x	x	x
SecurityCode	U	4		Instrument (or Book) code	x	x	x
OrderID	U	4		Application Order ID (unique at security level)	x	x	x
Side	C	1	'1' - Buy '2' - Sell	Side	x	x	x
Price	P	8		Limit price	x	x	x
OrderQty	Q	4		Total order volume	x	x	x
TimeInForce	C	1	See Table 3 – Order Types in “BMEGate Codification Tables”	GTD orders are not supported	x	x	x
AlgorithmicTradeIndicator	F	1		Algorithmic flag indicator	x	x	x
ClientID	U	4		Mifid II ClientID	x	x	x
AccountBolsa	C	16		Client code	x	x	
Account	C	5		Account	x	x	x
DEAFlag	F	1		Direct Electronic Access indicator	x	x	x
DecisorID	U	4		MIFID II DecisorID	x	x	x
ExecutorID	U	4		Mifid II ExecutorID	x	x	x
LiquidityProvisionActivity	F	1		Liquidity Provision Activity Flag	x	x	x
GiveInMember	C	4		Give-in member		x	x
AccountMember	C	4			x		
FirmMnemonic	C	10				x	x
AllocText	C	18				x	x
LastCapacity	C	1	D=Dealing on own account M=Matched principal A=Any Other Trading Capacity blanco		x	x	x
SelfMatchPreventionID	U	2				x	x
AutomaticOrderFilterFlag	C	1	2 - For orders entered by an authorized trader g - For authorized arbitration orders C - For orders not entered by an authorized trader			x	

Field	Type	Length	Valid values	Description	R F	R V	D E
			' ' - N/A				
ReceivedDeptID	C	1	I = Orders placed through the Internet B = Orders placed through the bank branch network T = Orders placed through automatic trading systems C = Orders placed by important clients O = Others ' ' = N/A (Workstation)				x
Persistence	C	1	C – Cancel on disconnection P – Persist on disconnection	Persistence type	x	x	x
AccountType	C	1	9 = Retail Service Specialist 8 = Retail customer (Supported for compatibility): A = On behalf of third parties P = House trader E = Specialist	Capacity Indicator			x
SelfMatchPreventionType	C	1	' ' = N/A or default behaviour (aggressive order is rejected) 1 = Reject aggressive order 2 = Cancel pasive order 3 = Cancel both passive and aggressive order				x x
ClientDataReference	C	15		Free to use by clients	x	x	x

6.3.5 Simple order modification (MsgType = 0x47)

Message sent by the client to modify an order. The field OrderID must contain the client reference of the order that is to be modified.

If the order is not found, no message will be answered to the client application.

Field	Type	Length	Valid values	Description	R F	R V	D E
MessageSize	U	2		Length of message, including this field	x	x	x
MessageType	U	1		Message type	x	x	x
RequestID	U	4		Request ID (for application feedback)	x	x	x
SecurityCode	U	4		Instrument (or Book) code	x	x	x
OrderID	U	4		Application Order ID (unique at security level)	x	x	x
Side	C	1	'1' - Buy '2' - Sell	Side	x	x	x
Price	P	8		Limit price	x	x	x
OrderQty	Q	4		New total intended Order Quantity (including the amount already executed for this chain of orders). For example, if the original order were of 20 securities, a partial execution of 5 securities took place, and the original order is wanted to reduce it in 1, this field should be accomplished with value 19. If it's being unchanged, must contain the same value as in the original order	x	x	x
ClientDataID	U	2	1-65535 (in response messages, 0 means no ClientDataID used)	Client Data ID (to be used as a shortcode in orders and quotes)	x	x	x

6.3.6 Simple order modification with Client Data (MsgType = 0x48)

Message sent by the client to modify an order. The field OrderID must contain the client reference of the order that is to be modified. The message also allows to assign new values for the Client Data parameters. Note that no ClientDataID may be assigned. It will be answered by a message Simple Order Status (MsgType = 0x02) where the value of ClientDataID field will be set to zero.

If the order is not found, no message will be answered to the client application.

Field	Type	Length	Valid values	Description	R F	R V	D E
MessageSize	U	2		Length of message, including this field	x	x	x
MessageType	U	1		Message type	x	x	x
RequestID	U	4		Request ID (for application feedback)	x	x	x
SecurityCode	U	4		Instrument (or Book) code	x	x	x
OrderID	U	4		Application Order ID (unique at security level)	x	x	x
Side	C	1	'1' - Buy '2' - Sell	Side	x	x	x
Price	P	8		Limit price	x	x	x
OrderQty	Q	4		New total intended Order Quantity (including the amount already executed for this chain of orders). For example, if the original order were of 20 securities, a partial execution of 5 securities took place, and the original order is wanted to reduce it in 1, this field should be accomplished with value 19. If it's being unchanged, must contain the same value as in the original order	x	x	x
AlgorithmicTradeIndicator	F	1		Algorithmic flag indicator	x	x	x
ClientID	U	4		Mifid II ClientID	x	x	x
AccountBolsa	C	16		Client code	x	x	
Account	C	5		Account	x	x	x
DEAFlag	F	1		Direct Electronic Access indicator	x	x	x
DecisorID	U	4		MIFID II DecisorID	x	x	x
ExecutorID	U	4		Mifid II ExecutorID	x	x	x
LiquidityProvisionActivity	F	1		Liquidity Provision Activity Flag	x	x	x
GiveInMember	C	4		Give-in member		x	x
AccountMember	C	4			x		

Field	Type	Length	Valid values	Description	R F	R V	D E
FirmMnemonic	C	10				x	x
AllocText	C	18				x	x
LastCapacity	C	1	D=Dealing on own account M=Matched principal A=Any Other Trading Capacity blanco		x	x	x
SelfMatchPreventionID	U	2				x	x
AutomaticOrderFilterFlag	C	1	2 - For orders entered by an authorized trader g - For authorized arbitration orders C - For orders not entered by an authorized trader ' ' - N/A			x	
ReceivedDeptID	C	1	I = Orders placed through the Internet B = Orders placed through the bank branch network T = Orders placed through automatic trading systems C = Orders placed by important clients O = Others ' ' = N/A (Workstation)				x
Persistence	C	1	C - Cancel on disconnection P - Persist on disconnection	Persistence type	x	x	x
AccountType	C	1	9 = Retail Service Specialist 8 = Retail customer (Supported for compatibility): A = On behalf of third parties P = House trader E = Specialist	Capacity Indicator		x	
SelfMatchPreventionType	C	1	' ' = N/A or default behaviour (aggressive order is rejected)			x	x

Field	Type	Length	Valid values	Description	R F	R V	D E
			1 = Reject aggressive order 2 = Cancel pasive order 3 = Cancel both passive and aggressive order				
ClientDataReference	C	15		Free to use by clients	x	x	x

6.3.7 Order cancellation request (MsgType = 0x46)

Message sent by the client to cancel an order. The field OrderID must contain a reference to the order that is to be cancelled.

If the order is not found, no message will be answered to the client application

Field	Type	Length	Valid values	Description	RF	RV	DE
MessageSize	U	2		Length of message, including this field	x	x	x
MessageType	U	1		Message type	x	x	x
RequestID	U	4		Request ID (for application feedback)	x	x	x
SecurityCode	U	4		Instrument (or Book) code	x	x	x
OrderID	U	4		Application Order ID (unique at security level)	x	x	x

6.3.8 New Quote (MsgType = 0x53)

Message sent by the client application to create a new quote.

A new quote by the same user on the same SecurityCode and with the same ClientDataID cancels the previous one.

Depending on the environment and its rules, a user can have just one quote per SecurityCode (Equities and Derivatives). In that case, any new quote in the same SecurityCode than a previous one replaces it.

In Fixed Income several quotes by the same user can coexist in the same SecurityCode. In this case the replacement will occur if there is an existing quote on the same combination of fields SecurityCode-ClientDataID.

Field	Type	Length	Valid values	Description	R F	R V	D E
MessageSize	U	2		Length of message, including this field	x	x	x
MessageType	U	1		Message type	x	x	x
RequestID	U	4		Request ID (for application feedback)	x	x	x
SecurityCode	U	4		Instrument (or Book) code	x	x	x
ClientDataID	U	2	1-65535 (in response messages, 0 means no ClientDataID used)	Client Data ID (to be used as a shortcode in orders and quotes)	x	x	x
BidSize1	Q	4		Buy volume	x	x	x
BidPx1	P	8		Buy price	x	x	x
AskSize1	Q	4		Sell volume	x	x	x
AskPx1	P	8		Sell price	x	x	x

6.3.9 Quote modification request (MsgType = 0x61)

Message sent by the client to modify a quote.

Field ClientDataID is required in RF to identify a quote. In RV and DE modifications of ClientDataID in a quote are not allowed.

Field	Type	Length	Valid values	Description	R F	R V	D E
MessageSize	U	2		Length of message, including this field	x	x	x
MessageType	U	1		Message type	x	x	x
RequestID	U	4		Request ID (for application feedback)	x	x	x
SecurityCode	U	4		Instrument (or Book) code	x	x	x
ClientDataID	U	2	1-65535 (in response messages, 0 means no ClientDataID used)	Client Data ID (to be used as a shortcode in orders and quotes) Modifications of this field in a quote are not allowed	x	x	x
BidPx1	P	8		Buy price	x	x	x
AskPx1	P	8		Sell price	x	x	x

6.3.10 Quote cancellation request (MsgType = 0x5A)

Message sent by the client to cancel a quote.

Field	Type	Length	Valid values	Description	R F	R V	D E
MessageSize	U	2		Length of message, including this field	x	x	x
MessageType	U	1		Message type	x	x	x
RequestID	U	4		Request ID (for application feedback)	x	x	x
SecurityCode	U	4		Instrument (or Book) code	x	x	x
ClientDataID	U	2	1-65535 (in response messages, 0 means no ClientDataID used)	Client Data ID (to be used as a shortcode in orders and quotes)	x	x	x

6.3.11 Mass order/quote cancellation (MsgType = 0x71)

Message sent by the client to request the cancellation of multiple orders and or quotes, based on the specified selection criteria.

Field	Type	Length	Valid values	Description	R F	R V	D E
MessageSize	U	2		Length of message, including this field	x	x	x
MessageType	U	1		Message type	x	x	x
RequestID	U	4		Request ID (for application feedback)	x	x	x
Account	C	5		Account	x		x
SecurityGroup	C	2	See Table 5 - Security Groups in "BMEGate Codification Tables" Use '??' if not specified	Security group			x
SecurityCode	U	4	Value 0 may be an accepted value meaning 'non-specified'	Instrument (or Book) code	x	x	x
ProductType	C	1	E Strategy F Future O Option R Roll-over ? Not specified	Derivative type			x
Side	C	1	'1' - Buy '2' - Sell '?' - Not-specified	Side	x	x	x
Cancellation Type	C	1	S - Standard P - Panic	Cancellation mode	x		
Issuer	C	12	Use '?????????????' if not specified	Issuer	x	x	
AccountBolsa	C	16	Use '?????????????????' if not specified	Client code	x	x	
AccountMember	C	4			x		
OrderOrQuoteCancel	C	1	N=Orders only Q=Quotes only T=Total cancellation (orders and quotes)	Cancellation of orders and/or quotes indicator	x	x	x

6.4 Definition of outbound messages

The TCP Order entry channel also publishes the following messages explained in chapter 3 as part of the TCP session level messages. Those messages are:

- Logon Response (see section 4.3.2): It will be the first message, and will indicate the protocol version number and the HeartBeat interval used in the connection.
- Logout Response (see section (0): It will be the last message of an orderly closed connection.
- HeartBeat (see section 0): It will be used to fill gaps with no application messages.
- Network Status (see section 0): It will be used to notify network related events.

It will also contain the following messages from the Public feed, that contain enough information for a Private connection:

- Order cancellation Market/Member (see section 0)
- Quote cancellation Market/Member (see section 0)

Based on the contents of the Subscriptions field in the Logon message, it may also always contain relevant messages available from the Market Information feed. Those messages are:

- Trading Session Status (see section 5.4.1): It will notify the different Trading phases.
- Security List and Security List Update Report (see sections 0 and 5.4.4): With information about the instruments that can be traded on the platform.
- Security Status and/or Family Status (see sections 0 and 0): They will notify changes in the status of instruments.
- Statistics (see section 0)
- Indications of Interest (see section 5.4.20) related to requests for orders.
- News (see section 5.4.22)

In a Market & Order Server it can also optionally contain other messages from the Market Information feed (depending on the Subscriptions field in the Logon message):

- Order information (see messages Order Book Clear, Top-of-Book During Auctions and Order Market Pre-Transparency Information in sections 0, 0 and 0)
- Trade Post-Transparency Information and Trade, Trade Amendment or Cancellation (see sections 0 and 0) for trades where the party is not involved.
- RFQ information including the Indications of Interest messages related to RFQs (see section 5.4.20) and RFQ Market Pre-Transparency Information (see section 0)

The following sections contain the definition of the rest of messages.

6.4.1 Order and Quote Client Data Parameters Ack/Nack (MsgType = 0x87)

Sent by the server to confirm an Order and Quote Client Data Parameters message.

Field	Type	Length	Valid values	Description	R F	R V	D E
MessageSize	U	2		Length of message, including this field	x	x	x
MessageType	U	1		Message type	x	x	x
SequenceNumber	U	4		Message sequence number	x	x	x
RequestID	U	4		Request ID (for application feedback)	x	x	x
Status	F	1	0x00 = Rejected/NACK 0x01 = Accepted/Ack	Request accepted or rejected	x	x	x
ClientDataID	U	2	1-65535 (in response messages, 0 means no ClientDataID used)	Client Data ID (to be used as a shortcode in orders and quotes)	x	x	x
AlgorithmicTradeIndicator	F	1		Algorithmic flag indicator	x	x	x
ClientID	U	4		Mifid II ClientID	x	x	x
AccountBolsa	C	16		Client code	x	x	
Account	C	5		Account	x	x	x
DEAFlag	F	1		Direct Electronic Access indicator	x	x	x
DecisorID	U	4		MIFID II DecisorID	x	x	x
ExecutorID	U	4		Mifid II ExecutorID	x	x	x
LiquidityProvisionActivity	F	1		Liquidity Provision Activity Flag	x	x	x
GiveInMember	C	4		Give-in member		x	x
AccountMember	C	4			x		
FirmMnemonic	C	10				x	x
AllocText	C	18				x	x
LastCapacity	C	1	D=Dealing on own account M=Matched principal A=Any Other Trading Capacity blanco		x	x	x
SelfMatchPreventionID	U	2				x	x
AutomaticOrderFilterFlag	C	1	"2 - For orders entered by an authorized trader g - For authorized arbitration orders C - For orders not entered by an authorized trader ' ' - N/A"			x	
ReceivedDeptID	C	1	I = Orders placed through the Internet			x	

Field	Type	Length	Valid values	Description	R F	R V	D E
			B = Orders placed through the bank branch network T = Orders placed through automatic trading systems C = Orders placed by important clients O = Others ' ' = N/A (Workstation)"				
Persistence	C	1	C – Cancel on disconnection P – Persist on disconnection	Persistence type	x	x	x
			9 = Retail Service Specialist 8 = Retail customer				
AccountType	C	1	(Supported for compatibility): A = On behalf of third parties P = House trader E = Specialist	Capacity Indicator			x
			' ' = N/A or default behaviour (aggressive order is rejected) 1 = Reject aggressive order 2 = Cancel pasive order 3 = Cancel both passive and aggressive order				
SelfMatchPreventionType	C	1					x x
ClientDataReference	C	15		Free to use by clients	x	x	x

6.4.2 Delta Protection Parameters Ack/Nack (MsgType = 0x88)

Sent by the server to confirm a Delta Protection Parameters message.

Field	Type	Length	Valid values	Description	DE
MessageSize	U	2		Length of message, including this field	x
MessageType	U	1		Message type	x
SequenceNumber	U	4		Message sequence number	x
RequestID	U	4		Request ID (for application feedback)	x
Status	F	1	0x00 = Rejected/Nack 0x01 = Accepted/Ack	Request accepted or rejected	x
SecurityGroup	C	2	See Table 5 - Security Groups in "BMEGate Codification Tables"	Underlying code	x
ProductType	C	1	F Future O Option	Derivative type	x
DeltaProtectionTime	U	1		Number of seconds for Delta Protection control	x
DeltaProtectionVolume	Q	4		Total maximum volume during DeltaProtectionTime	x

6.4.3 Simple Order Status (MsgType = 0x02)

Sent by the server to inform about the order status.

Please note that the first fields of this message are the same as the ones for Order Market Pre-Transparency Information (Msg Type = 0x03) (see section 5.4.12).

Field	Type	Length	Valid values	Description	R	R	D
					F	V	E
MessageSize	U	2		Length of message, including this field	x	x	x
MessageType	U	1		Message type	x	x	x
SequenceNumber	U	4		Message sequence number	x	x	x
SecurityCode	U	4		Instrument (or Book) code	x	x	x
TransactionDateAndTime	T	8		Transaction Date and Time in nanoseconds since 1-jan-1970 UTC	x	x	x
SecondaryOrderID	U	4		System Order Number	x	x	x
EntryDate	D	4		System order entry date (when System Order Number was assigned)	x	x	x
Side	C	1	'1' - Buy '2' - Sell	Side	x	x	x
Priority	U	4		Priority	x	x	x
Price	P	8		Limit price	x	x	x
DisplayQty	Q	4		Visible pending volume	x	x	x
AltPrice	P	8		Yield or percent of par	x		
OrderID	U	4		Application Order ID (unique at security level)	x	x	x
SecondaryExecID	U	4		History number	x	x	x
OrderQty	Q	4		Total order volume	x	x	x
OrdStatus	C	1	0 = Pending (no volume filled) 8 = Rejected 1 = Partially filled 2 = Totally Filled 4 = Cancelled (not filled) P= Cancelled (partially filled) A = Non-working order (Pending validation) S = Non-working order (Pending activation)	Order Status	x	x	x
OrdRejReason	C	1	See Table 20 - Order/Quote. Reason for Cancellation/Reject in "BMEGate Codification Tables"	Reason	x	x	x

Field	Type	Length	Valid values	Description	R F	R V	D E
ExecType	C	1	A: New order confirmation B: Order cancellation M: Order modification G: Order modification deleting Intermediated Member F: Order modification changing Intermediated Member R: Order refresh D: Stop order triggered, at-the-close order activation 8: Order rejection N: Order pending validation P: Order modification pending validation V: Order refresh due to new DisplayQty I: Beginning of day order refresh X: Expired order W: order status	Confirmation type	x	x	x
RequestID	U	4		Request ID (for application feedback)	x	x	x
ClientDataID	U	2	1-65535 (in response messages, 0 means no ClientDataID used)	Client Data ID (to be used as a shortcode in orders and quotes)	x	x	x

6.4.4 Quote Status (MsgType = 0x06)

Sent by the server to inform about the status of a Quote.

Field	Type	Length	Valid values	Description	R F	R V	D E
MessageSize	U	2		Length of message, including this field	x	x	x
MessageType	U	1		Message type	x	x	x
SequenceNumber	U	4		Message sequence number	x	x	x
SecurityCode	U	4		Instrument (or Book) code	x	x	x
TransactionDateAndTime	T	8		Transaction Date and Time in nanoseconds since 1-jan-1970 UTC	x	x	x
SecondaryOrderID	U	4		System Order Number	x	x	x
SecondaryOrderID2	U	4		System Order Number	x	x	x
Priority	U	4		Priority	x	x	x
Price	P	8		Limit price	x	x	x
DisplayQty	Q	4		Visible pending volume	x	x	x
AltPrice	P	8		Yield or percent of par	x		
Priority2	U	4		Priority	x	x	x
Price2	P	8		Limit price	x	x	x
DisplayQty2	Q	4		Visible pending volume	x	x	x
AltPrice2	P	8		Yield or percent of par	x		
OrderID	U	4		Application Order ID (unique at security level)	x	x	x
SecondaryExecID	U	4		History number	x	x	x
OrderQty	Q	4		Total order volume	x	x	x
OrdStatus	C	1	0 = Pending (no volume filled) 8 = Rejected 1 = Partially filled 2 = Totally Filled 4 = Cancelled (not filled) P= Cancelled (partially filled) A = Non-working order (Pending validation) S = Non-working order (Pending activation)	Order Status	x	x	x
OrdRejReason	C	1	See Table 20 – Order/Quote. Reason for Cancellation/Reject in “BMEGate Codification Tables”	Reason	x	x	x

Field	Type	Length	Valid values	Description	R F	R V	D E
ExecType	C	1	A: New order confirmation B: Order cancellation M: Order modification R: Order refresh 8: Order rejection X: Expired order W: order status	Confirmation type	x	x	x
OrderID2	U	4		Application Order ID (unique at security level)	x	x	x
SecondaryExecID2	U	4		History number	x	x	x
OrderQty2	Q	4		Total order volume	x	x	x
OrdStatus2	C	1	0 = Pending (no volume filled) 8 = Rejected 1 = Partially filled 2 = Totally Filled 4 = Cancelled (not filled) P= Cancelled (partially filled) A = Non-working order (Pending validation) S = Non-working order (Pending activation)	Order Status	x	x	x
OrdRejReason2	C	1	See Table 20 – Order/Quote. Reason for Cancellation/Reject in “BMEGate Codification Tables”	Reason	x	x	x
ExecType2	C	1	A: New order confirmation B: Order cancellation M: Order modification R: Order refresh 8: Order rejection X: Expired order W: order status	Confirmation type	x	x	x
RequestID	U	4		Request ID (for application feedback)	x	x	x
ClientDataID	U	2	1-65535 (in response messages, 0 means no ClientDataID used)	Client Data ID (to be used as a shortcode in orders and quotes)	x	x	x

6.4.5 Order Cancel Reject (MsgType = 0x39)

Sent by the server to inform about the rejection of a Simple order modification (MsgType = 0x47) or an Order cancellation request (MsgType = 0x46).

Field	Type	Length	Valid values	Description	R F	R V	DE
MessageSize	U	2		Length of message, including this field	x	x	x
MessageType	U	1	0x39	Message type	x	x	x
Sequence Number	U	4		Message sequence number	x	x	x
TransactionDateAndTime	T	8		Transaction Date and Time in nanoseconds since 1-jan-1970 UTC	x	x	x
OrderID	U	4		Order that could not be modified or cancelled	x	x	x
OrdStatus	C	1	0 = Pending (no volume filled) 1 = Partially filled 2 = Totally Filled 4 = Cancelled (not filled) 8 = Rejected C = Expired	Order status. It is 8 (Rejected) if OrderID is unknown.	x	x	x
CxlRejResponseTo	C	1	1 = Simple order modification 2 = Order cancellation request	Type of message responded to	x	x	x
CxlRejReason	C	1	See Table 20 – Order/Quote. Reason for Cancellation/Reject in “BMEGate Codification Tables”	Rejection motive.	x	x	x
RequestID	U	4		Request ID (for application feedback)	x	x	x

6.4.6 Mass order/quote cancellation completion (MsgType = 0x72)

Message reporting the completion of a valid mass order cancellation request.

More than one message may be sent for a single RequestID. There will be as many as trading units in the central systems have processed the mass order/quote cancellation request. Each trading unit will send this message after all the order status messages reporting the individual orders cancellations, if there has been any.

If a trading unit receives a message Mass order/quote cancellation (MsgType = 0x72) which is a valid request, but it has no orders to cancel, it will answer with a Mass order/quote cancellation completion (MsgType = 0x72) with no preceding orders cancellations.

Field	Type	Length	Valid values	Description	R F	R V	DE
MessageSize	U	2		Length of message, including this field	x	x	x
MessageType	U	1	0x72	Message type	x	x	x
Sequence Number	U	4		Message sequence number	x	x	x
TransactionDateAndTime	T	8		Transaction Date and Time in nanoseconds since 1-jan-1970 UTC	x	x	x
TradingUnit	U	1		Trading unit ID in the central systems	x	x	x
CancellationType	C	1	S - Standard P - Panic	Contains the same value as specified in the request	x		
OrderOrQuoteCancellation	C	1	N=Orders only Q=Quotes only T=Total cancellation (orders and quotes)	Contains the same value as specified in request	x	x	x
RequestID	U	4		Request ID (for application feedback)	x	x	x

6.4.7 Mass order/quote cancellation reject (MsgType = 0x73)

Message reporting the rejection of a mass order cancellation request.

More than one message may be sent for a single RequestID. There will be as many as trading units in the central systems have rejected the mass order/quote cancellation request.

A trading unit will not answer with a rejection a valid mass order/quote cancellation request. In section 6.4.6 Mass order/quote cancellation completion (MsgType = 0x72) is explained that it will answer with just a message Mass order/quote completion (MsgType = 0x72) if it has no orders to cancel.

Field	Type	Length	Valid values	Description	RF	RV	DE
MessageSize	U	2		Length of message, including this field	x	x	x
MessageType	U	1	0x73	Message type	x	x	x
SequenceNumber	U	4		Message sequence number	x	x	x
TransactionDateAndTime	T	8		Transaction Date and Time in nanoseconds since 1-jan-1970 UTC	x	x	x
TradingUnit	U	1		Trading unit ID in the central systems	x	x	x
MassCancelRejectReason	C	1	G = No permission 8 = Cancelled because of market state 9 = Invalid data	Rejection motive	x	x	x
RequestID	U	4		Request ID (for application feedback)	x	x	x

6.4.8 Execution Private Information 1 Leg Buy (Order Entry) (MsgType = 0x12)

Sent by the server to inform about a trade where the user is involved as Buyer.

Shares the same layout as the next message

6.4.9 Execution Private Information 1 Leg Sell (Order Entry) (MsgType = 0x14)

Sent by the server to inform about a trade where the user is involved as Seller.

Field	Type	Length	Valid values	Description	R F	R V	D E
MessageSize	U	2		Length of message, including this field	x	x	x
MessageType	U	1		Message type	x	x	x
Sequence Number	U	4		Message sequence number	x	x	x
SecurityCode	U	4		Instrument (or Book) code	x	x	x
TransactionDateAndTime	T	8		Transaction Date and Time in nanoseconds since 1-jan-1970 UTC	x	x	x
MarketSegmentID	C	4		MIC Code	x	x	x
TradingSessionID	U	1	See Table 25 – TradingSessionID in “BMEGate Codification Tables”	Trading mode	x	x	x
TrdMatchID	U	4		System Trade Number	x	x	x
TradeType	C	1	See Table 4 - Trade types in “BMEGate Codification Tables”	Trade type	x	x	x
LastPX	P	8		Trade price	x	x	x
LastQty	Q	4		Current trade volume	x	x	x
GrossTradeAmt	A	8		Premium / Trade amount	x	x	x
Designation	C	1	'1' Trade during Open Market '2' Trade during Opening Auction '3' Trade during Closing Auction '4' Trade during volatility auction '5' Trade during manual auction '6' Trade during opening auction extension '7' Trade during closing auction extension '8' Trade during TAL period	Trade situation	x	x	x
MarketMechanism	C	1	See Table 28 – Level 1	Market Mechanism	x	x	x
AlgoFlag	F	1	Flag ALGO RTS1	Algorithmic flag indicator	x	x	x
BuyerBolsaCode	C	1	See Table 15 - Bolsa code belonging to the member (buy side) in “BMEGate Codification Tables”	Stock Exchange code of the buyer		x	
AltLastPX	P	8		Trade yield or percent of par	x		

Field	Type	Length	Valid values	Description	R F	R V	D E
AccruedInterestAmt	A	8		Accrued Interest amount	x		
AccruedInterestRate	P	8		Interest rate of coupon	x		
SettleDate	D	4		Settlement date	x	x	
TransactionCategory	C	1	See Table 28 – Level 3.1		x	x	x
StrategyTradeMatchID	U	4		System Trade Number of the time-spread or strategy			x
SecondaryOrderID	U	4		System Order Number	x	x	x
EntryDate	D	4		System order entry date (when System Order Number was assigned)	x	x	x
Priority	U	4		Priority	x	x	x
Price	P	8		Limit price	x	x	x
DisplayQty	Q	4		Visible pending volume	x	x	x
AltPrice	P	8		Yield or percent of par	x		
OrderID	U	4		Application Order ID (unique at security level)	x	x	x
SecondaryExecID	U	4		History number	x	x	x
OrderQty	Q	4		Total order volume	x	x	x
OrdStatus	C	1	0 = Pending (no volume filled) 8 = Rejected 1 = Partially filled 2 = Totally Filled 4 = Cancelled (not filled) P= Cancelled (partially filled) A = Non-working order (Pending validation) S = Non-working order (Pending activation)	Order Status	x	x	x
CCPCode	C	1	'0' - N/A '1' - BME Clearing ... Others to be defined	CCP Code	x	x	x
AggressorIndicator	C	1	': N/A P: Passive A: Aggressive	Passive or aggressive indicator	x	x	x
RequestID	U	4		Request ID (for application feedback)	x	x	x
ClientDataID	U	2	1-65535 (in response messages, 0 means no ClientDataID used)	Client Data ID (to be used as a shortcode in orders and quotes)	x	x	x

6.4.10 Execution Private Information 1 Leg Buy (Market & Order) (MsgType = 0x13)

Sent by the server to inform about a trade where the user is involved as Buyer.

In the order where the member is not involved, only the market information is sent, so that the application can update the books.

Field	Type	Length	Valid values	Description	R F	R V	D E
MessageSize	U	2		Length of message, including this field	x	x	x
MessageType	U	1		Message type	x	x	x
Sequence Number	U	4		Message sequence number	x	x	x
SecurityCode	U	4		Instrument (or Book) code	x	x	x
TransactionDateAndTime	T	8		Transaction Date and Time in nanoseconds since 1-jan-1970 UTC	x	x	x
MarketSegmentID	C	4		MIC Code	x	x	x
TradingSessionID	U	1	See Table 25 – TradingSessionID in “BMEGate Codification Tables”	Trading mode	x	x	x
TrdMatchID	U	4		System Trade Number	x	x	x
TradeType	C	1	See Table 4 - Trade types in “BMEGate Codification Tables”	Trade type	x	x	x
LastPX	P	8		Trade price	x	x	x
LastQty	Q	4		Current trade volume	x	x	x
GrossTradeAmt	A	8		Premium / Trade amount	x	x	x
Designation	C	1	'1' Trade during Open Market '2' Trade during Opening Auction '3' Trade during Closing Auction '4' Trade during volatility auction '5' Trade during manual auction '6' Trade during opening auction extension '7' Trade during closing auction extension '8' Trade during TAL period	Trade situation	x	x	x
MarketMechanism	C	1	See Table 28 – Level 1	Market Mechanism	x	x	x
AlgoFlag	F	1	Flag ALGO RTS1	Algorithmic flag indicator	x	x	x
BuyerBolsaCode	C	1	See Table 15 - Bolsa code belonging to the member (buy side) in “BMEGate Codification Tables”	Stock Exchange code of the buyer		x	
AltLastPX	P	8		Trade yield or percent of par	x		

Field	Type	Length	Valid values	Description	R F	R V	D E
AccruedInterestAmt	A	8		Accrued Interest amount	x		
AccruedInterestRate	P	8		Interest rate of coupon	x		
SettleDate	D	4		Settlement date	x	x	
TransactionCategory	C	1	See Table 28 – Level 3.1		x	x	x
StrategyTradeMatchID	U	4		System Trade Number of the time-spread or strategy			x
SecondaryOrderID	U	4		System Order Number	x	x	x
EntryDate	D	4		System order entry date (when System Order Number was assigned)	x	x	x
Priority	U	4		Priority	x	x	x
Price	P	8		Limit price	x	x	x
DisplayQty	Q	4		Visible pending volume	x	x	x
AltPrice	P	8		Yield or percent of par	x		
OrderID	U	4		Application Order ID (unique at security level)	x	x	x
SecondaryExecID	U	4		History number	x	x	x
OrderQty	Q	4		Total order volume	x	x	x
OrdStatus	C	1	0 = Pending (no volume filled) 8 = Rejected 1 = Partially filled 2 = Totally Filled 4 = Cancelled (not filled) P= Cancelled (partially filled) A = Non-working order (Pending validation) S = Non-working order (Pending activation)	Order Status	x	x	x
CCPCode	C	1	'0' - N/A '1' - BME Clearing ... Others to be defined	CCP Code	x	x	x
AggressorIndicator	C	1	': N/A P: Passive A: Aggressive	Passive or aggressive indicator	x	x	x
RequestID	U	4		Request ID (for application feedback)	x	x	x
ClientDataID	U	2	1-65535 (in response messages, 0 means no ClientDataID used)	Client Data ID (to be used as a shortcode in orders and quotes)	x	x	x
SecondaryOrderID2	U	4		System Order Number	x	x	x

Field	Type	Length	Valid values	Description	R F	R V	D E
EntryDate2	D	4		System order entry date (when System Order Number was assigned)	x	x	x
Priority2	U	4		Priority	x	x	x
Price2	P	8		Limit price	x	x	x
DisplayQty 2	Q	4		Visible pending volume	x	x	x
AltPrice2	P	8		Yield or percent of par	x		
RetailFlag2	F	1		Order/Quote only for retailers		x	
RetailCIFla g2	F	1		Retail Client Indicator			x

6.4.11 Execution Private Information 1 Leg Sell (Market & Order) (MsgType = 0x15)

Sent by the server to inform about a trade where the user is involved as Seller.

In the order where the member is not involved, only the market information is sent, so that the application can update the books.

The message is equivalent to the previous one, but taking into account the order of the leg information.

Field	Type	Length	Valid values	Description	R F	R V	D E
MessageSize	U	2		Length of message, including this field	x	x	x
MessageType	U	1		Message type	x	x	x
Sequence Number	U	4		Message sequence number	x	x	x
SecurityCode	U	4		Instrument (or Book) code	x	x	x
TransactionDateAndTime	T	8		Transaction Date and Time in nanoseconds since 1-jan-1970 UTC	x	x	x
MarketSegmentID	C	4		MIC Code	x	x	x
TradingSessionID	U	1	See Table 25 - TradingSessionID in "BMEGate Codification Tables"	Trading mode	x	x	x
TrdMatchID	U	4		System Trade Number	x	x	x
TradeType	C	1	See Table 4 - Trade types in "BMEGate Codification Tables"	Trade type	x	x	x
LastPX	P	8		Trade price	x	x	x
LastQty	Q	4		Current trade volume	x	x	x
GrossTradeAmt	A	8		Premium / Trade amount	x	x	x
Designation	C	1	'1' Trade during Open Market '2' Trade during Opening Auction '3' Trade during Closing Auction '4' Trade during volatility auction '5' Trade during manual auction '6' Trade during opening auction extension '7' Trade during closing auction extension '8' Trade during TAL period	Trade situation	x	x	x
MarketMechanism	C	1	See Table 28 - Level 1	Market Mechanism	x	x	x
AlgoFlag	F	1	Flag ALGO RTS1	Algorithmic flag indicator	x	x	x
BuyerBolsaCode	C	1	See Table 15 - Bolsa code belonging to the member (buy side) in "BMEGate Codification Tables"	Stock Exchange code of the buyer		x	
AltLastPX	P	8		Trade yield or percent of par	x		

Field	Type	Length	Valid values	Description	R F	R V	D E
AccruedInterestAmt	A	8		Accrued Interest amount	x		
AccruedInterestRate	P	8		Interest rate of coupon	x		
SettleDate	D	4		Settlement date	x	x	
TransactionCategory	C	1	See Table 28 – Level 3.1		x	x	x
StrategyTradeMatchID	U	4		System Trade Number of the time-spread or strategy			x
SecondaryOrderID	U	4		System Order Number	x	x	x
EntryDate	D	4		System order entry date (when System Order Number was assigned)	x	x	x
Priority	U	4		Priority	x	x	x
Price	P	8		Limit price	x	x	x
DisplayQty	Q	4		Visible pending volume	x	x	x
AltPrice	P	8		Yield or percent of par	x		
RetailFlag	F	1		Order/Quote only for retailers			x
RetailClientFlag	F	1		Retail Client Indicator			x
SecondaryOrderID2	U	4		System Order Number	x	x	x
EntryDate2	D	4		System order entry date (when System Order Number was assigned)	x	x	x
Priority2	U	4		Priority	x	x	x
Price2	P	8		Limit price	x	x	x
DisplayQty2	Q	4		Visible pending volume	x	x	x
AltPrice2	P	8		Yield or percent of par	x		
OrderID2	U	4		Application Order ID (unique at security level)	x	x	x
SecondaryExecID2	U	4		History number	x	x	x
OrderQty2	Q	4		Total order volume	x	x	x
OrdStatus2	C	1	0 = Pending (no volume filled) 8 = Rejected 1 = Partially filled 2 = Totally Filled 4 = Cancelled (not filled) P= Cancelled (partially filled) A = Non-working order (Pending validation) S = Non-working order (Pending activation)	Order Status	x	x	x

Field	Type	Length	Valid values	Description	R F	R V	D E
CCPCode2	C	1	'0' - N/A '1' - BME Clearing ... Others to be defined	CCP Code	x	x	x
AggressorIndicator2	C	1	'': N/A P: Passive A: 127assive127ve	Passive or aggressive indicator	x	x	x
RequestID2	U	4		Request ID (for application feedback)	x	x	x
ClientDataID2	B	2	1-65535 (in response messages, 0 means no ClientDataID used)	Client Data ID (to be used as a shortcode in orders and quotes)	x	x	x

6.4.12 Execution Private Information 2 Legs (MsgType = 0x17)

Sent by the server to inform about a trade where two orders of the user are involved both as Buyer and Seller.

Field	Type	Length	Valid values	Description	R F	R V	D E
MessageSize	U	2		Length of message, including this field	x	x	x
MessageType	U	1		Message type	x	x	x
Sequence Number	U	4		Message sequence number	x	x	x
SecurityCode	U	4		Instrument (or Book) code	x	x	x
TransactionDateAndTime	T	8		Transaction Date and Time in nanoseconds since 1-jan-1970 UTC	x	x	x
MarketSegmentID	C	4		MIC Code	x	x	x
TradingSessionID	U	1	See Table 25 – TradingSessionID in “BMEGate Codification Tables”	Trading mode	x	x	x
TrdMatchID	U	4		System Trade Number	x	x	x
TradeType	C	1	See Table 4 – Trade types in “BMEGate Codification Tables”	Trade type	x	x	x
LastPX	P	8		Trade price	x	x	x
LastQty	Q	4		Current trade volume	x	x	x
GrossTradeAmt	A	8		Premium / Trade amount	x	x	x
Designation	C	1	'1' Trade during Open Market '2' Trade during Opening Auction '3' Trade during Closing Auction '4' Trade during volatility auction '5' Trade during manual auction '6' Trade during opening auction extension '7' Trade during closing auction extension '8' Trade during TAL period	Trade situation	x	x	x
MarketMechanism	C	1	See Table 28 – Level 1	Market Mechanism	x	x	x
AlgoFlag	F	1	Flag ALGO RTS1	Algorithmic flag indicator	x	x	x
BuyerBolsaCode	C	1	See Table 15 – Bolsa code belonging to the member (buy side) in “BMEGate Codification Tables”	Stock Exchange code of the buyer		x	
AltLastPX	P	8		Trade yield or percent of par	x		
AccruedInterestAmt	A	8		Accrued Interest amount	x		

Field	Type	Length	Valid values	Description	R F	R V	D E
AccruedInterestRate	P	8		Interest rate of coupon	x		
SettleDate	D	4		Settlement date	x	x	
TransactionCategory	C	1	See Table 28 - Level 3.1		x	x	x
StrategyTradeMatchID	U	4		System Trade Number of the time-spread or strategy			x
SecondaryOrderID	U	4		System Order Number	x	x	x
EntryDate	D	4		System order entry date (when System Order Number was assigned)	x	x	x
Priority	U	4		Priority	x	x	x
Price	P	8		Limit price	x	x	x
DisplayQty	Q	4		Visible pending volume	x	x	x
AltPrice	P	8		Yield or percent of par	x		
OrderID	U	4		Application Order ID (unique at security level)	x	x	x
SecondaryExecID	U	4		History number	x	x	x
OrderQty	Q	4		Total order volume	x	x	x
OrdStatus	C	1	0 = Pending (no volume filled) 8 = Rejected 1 = Partially filled 2 = Totally Filled 4 = Cancelled (not filled) P= Cancelled (partially filled) A = Non-working order (Pending validation) S = Non-working order (Pending activation)	Order Status	x	x	x
CCPCode	C	1	'0' - N/A '1' - BME Clearing ... Others to be defined	CCP Code	x	x	x
AggressorIndicator	C	1	': N/A P: Passive A: 129assive129ve	Passive or aggressive indicator	x	x	x
RequestID	U	4		Request ID (for application feedback)	x	x	x
ClientDataID	U	2	1-65535 (in response messages, 0 means no ClientDataID used)	Client Data ID (to be used as a shortcode in orders and quotes)	x	x	x
SecondaryOrderID2	U	4		System Order Number	x	x	x
EntryDate2	D	4		System order entry date (when System Order Number was assigned)	x	x	x

Field	Type	Length	Valid values	Description	R F	R V	D E
Priority2	U	4		Priority	x	x	x
Price2	P	8		Limit price	x	x	x
DisplayQty2	Q	4		Visible pending volume	x	x	x
AltPrice2	P	8		Yield or percent of par	x		
OrderID2	U	4		Application Order ID (unique at security level)	x	x	x
Secondary ExecID2	U	4		History number	x	x	x
OrderQty2	Q	4		Total order volume	x	x	x
OrdStatus2	C	1	0 = Pending (no volume filled) 8 = Rejected 1 = Partially filled 2 = Totally Filled 4 = Cancelled (not filled) P= Cancelled (partially filled) A = Non-working order (Pending validation) S = Non-working order (Pending activation)	Order Status	x	x	x
CCPCode2	C	1	'0' - N/A '1' - BME Clearing ... Others to be defined	CCP Code	x	x	x
AggressorIndicator2	C	1	': N/A P: Passive A: 130assive130ve	Passive or aggressive indicator	x	x	x
RequestID2	U	4		Request ID (for application feedback)	x	x	x
ClientDataID2	U	2	1-65535 (in response messages, 0 means no ClientDataID used)	Client Data ID (to be used as a shortcode in orders and quotes)	x	x	x

6.4.13 Trade, Trade Amendment or Cancellation 1 Leg Buy Private Information (MsgType = 0x1A)

Sent by the server to inform about a trade produced due to any reason other than order matching. The user is involved in the trade as Buyer. It is also sent to inform about the amendment or cancellation of whatever origin trade where the user is involved as Buyer.

Shares the same layout as the next message.

6.4.14 Trade, Trade Amendment or Cancellation 1 Leg Sell Private Information (MsgType = 0x1C)

Sent by the server to inform about a trade produced due to any reason other than order matching. The user is involved in the trade as Seller. It is also sent to inform about the amendment or cancellation of whatever origin trade where the user is involved as Seller.

Field	Type	Length	Valid values	Description	R F	R V	D E
MessageSize	U	2		Length of message, including this field	x	x	x
MessageType	U	1		Message type	x	x	x
SequenceNumber	U	4		Message sequence number	x	x	x
SecurityCode	U	4		Instrument (or Book) code	x	x	x
TransactionDateAndTime	T	8		Transaction Date and Time in nanoseconds since 1-jan-1970 UTC	x	x	x
MarketSegmentID	C	4		MIC Code	x	x	x
TradingSessionID	U	1	See Table 25 – TradingSessionID in “BMEGate Codification Tables”	Trading mode	x	x	x
TrdMatchID	U	4		System Trade Number	x	x	x
TradeType	C	1	See Table 4 – Trade types in “BMEGate Codification Tables”	Trade type	x	x	x
LastPX	P	8		Trade price	x	x	x
LastQty	Q	4		Current trade volume	x	x	x
GrossTradeAmt	A	8		Premium / Trade amount	x	x	x
Designation	C	1	'1' Trade during Open Market '2' Trade during Opening Auction '3' Trade during Closing Auction '4' Trade during volatility auction '5' Trade during manual auction '6' Trade during opening auction extension '7' Trade during closing auction extension '8' Trade during TAL period	Trade situation	x	x	x

Field	Type	Length	Valid values	Description	R F	R V	D E
MarketMechanism	C	1	See Table 28 – Level 1	Market Mechanism	x	x	x
AlgoFlag	F	1	Flag ALGO RTS1	Algorithmic flag indicator	x	x	x
BuyerBolsaCode	C	1	See Table 15 – Bolsa code belonging to the member (buy side) in “BMEGate Codification Tables”	Stock Exchange code of the buyer		x	
AltLastPX	P	8		Trade yield or percent of par	x		
AccruedInterestAmt	A	8		Accrued Interest amount	x		
AccruedInterestRate	P	8		Interest rate of coupon	x		
SettlDate	D	4		Settlement date	x	x	
TransactionCategory	C	1	See Table 28 – Level 3.1		x	x	x
StrategyTrdMatchID	U	4		System Trade Number of the time-spread or strategy			x
LastChangeFlag	B	1		Indicates if this trade changes the instrument Last price	x	x	x
BENC_RFPT_Flag	C	1	See Table 28 – Levels 3.5, 3.11 and 3.12	Benchmark or Reference Price Indicator MMT	x	x	x
TradePriceCondition	C	1	See Table 28 – Level 3.8	MMT 3.8	x	x	x
PreTradeTransparencyWaiver	C	1	See Table 28 – Levels 3.2 and 3.10	Pre-trade transparency waiver	x	x	x
DeferralWaiver	C	1	See Table 28 – Levels 4.1, 4.3 and 4.4	Deferral Waiver	x	x	x
PostDeferralPublicationType	C	1	See Table 28 – Level 4.2	Post-deferral publication type	x		x
PublishDateAndTime	T	8		Publication Date and Time in nanoseconds since 1-jan-1970 UTC	x	x	x
TradeDate	T	8		Trade date and time	x	x	x
TradeSessionDate	D	4		Trade Session Date	x	x	x
SettlDate2	D	4		Settlement date of the second leg	x		
EndCash	A	8		Amount to be settled at the end of the Repo Trade	x		
VolumeFloat	V	8		Volume with decimal places		x	
SICAVFundCounterpartySide	C	1	'1' = Buyer '2' = Seller '' = N/A	Indicates the side of the Counterparty member in a SICAV or Mutual Fund			x
AmendedTradeType	C	1	See Table 4 – Trade types in “BMEGate Codification Tables	Trade type of the amended/cancelled trade	x	x	x

Field	Type	Length	Valid values	Description	R F	R V	D E
ExecRefID	U	4		System Trade Number of the amended/cancelled trade	x	x	x
AmendedTradeDate	D	4		Date of the amended/cancelled trade	x	x	x
Broker	C	4					x
BrokerTrader	C	3			x		x
BrokerText	C	15			x		x
SecondaryOrderID	U	4		System Order Number	x	x	x
EntryDate	D	4		System order entry date (when System Order Number was assigned)	x	x	x
Priority	U	4		Priority	x	x	x
Price	P	8		Limit price	x	x	x
DisplayQty	Q	4		Visible pending volume	x	x	x
AltPrice	P	8		Yield or percent of par	x		
OrderID	U	4		Application Order ID (unique at security level)	x	x	x
SecondaryExecID	U	4		History number	x	x	x
OrderQty	Q	4		Total order volume	x	x	x
OrdStatus	C	1	0 = Pending (no volume filled) 8 = Rejected 1 = Partially filled 2 = Totally Filled 4 = Cancelled (not filled) P= Cancelled (partially filled) A = Non-working order (Pending validation) S = Non-working order (Pending activation)	Order Status	x	x	x
CCPCode	C	1	'0' - N/A '1' - BME Clearing ... Others to be defined	CCP Code	x	x	x
AggressorIndicator	C	1	': N/A P: Passive A: 133assive133ve	Passive or aggressive indicator	x	x	x
RequestID	U	4		Request ID (for application feedback)	x	x	x
ClientDataID	U	2	1-65535 (in response messages, 0 means no ClientDataID used)	Client Data ID (to be used as a shortcode in orders and quotes)	x	x	x
AlgorithmicTradeIndicator	F	1		Algorithmic flag indicator	x	x	x

Field	Type	Length	Valid values	Description	R F	R V	D E
ClientID	U	4		Mifid II ClientID	x	x	x
AccountBolsa	C	16		Client code	x	x	
Account	C	5		Account	x	x	x
DEAFlag	F	1		Direct Electronic Access indicator	x	x	x
DecisorID	U	4		MIFID II DecisorID	x	x	x
ExecutorID	U	4		Mifid II ExecutorID	x	x	x
LiquidityProvisionActivity	F	1		Liquidity Provision Activity Flag	x	x	x
GiveInMember	C	4		Give-in member		x	x
AccountMember	C	4			x		
FirmMnemonic	C	10				x	x
AllocText	C	18				x	x
LastCapacity	C	1	D=Dealing on own account M=Matched principal A=Any Other Trading Capacity blanco		x	x	x
SelfMatchPreventionID	U	2				x	x
AutomaticOrderFilterFlag	C	1	2 - For orders entered by an authorized trader g - For authorized arbitration orders C - For orders not entered by an authorized trader '' - N/A			x	
ReceivedDeptID	C	1	I = Orders placed through the Internet B = Orders placed through the bank branch network T = Orders placed through automatic trading systems C = Orders placed by important clients O = Others '' = N/A (Workstation)			x	
Persistence	C	1	C - Cancel on disconnection P - Persist on disconnection	Persistence type	x	x	x
AccountType	C	1	9 = Retail Service Specialist 33 = Retail customer (Supported for compatibility): A = On behalf of third parties P = House trader	Capacity Indicator		x	

Field	Type	Length	Valid values	Description	R F	R V	D E
			E = Specialist				
SelfMatchPreventionType	C	1	' ' = N/A or default behaviour (aggressive order is rejected) 1 = Reject aggressive order 2 = Cancel 135assive order 3 = Cancel both passive and aggressive order			x	x
Member	C	4		Member	x	x	x
Trader	C	3		Trader	x	x	x
SubMember	C	1		Submember code	x	x	x
CrossId	U	4		Cross Trade Unique Identifier	x	x	x
BolsaCode	C	1	See Table 15 – Bolsa code belonging to the member (buy side) in “BMEGate Codification Tables”	Bolsa code (Madrid, Barcelona, Bilbao, Valencia)		x	
CSDBIC	C	11		BIC of the Central Securities Depository		x	
Participant	C	11		Participant		x	
CtaLiq	C	35		Securities Account code in CSD		x	
CCV	C	20		Securities Account code in CSD		x	x
OrderSecurityCode	U	4		Order instrument (or Book) code	x	x	x
ExternalMember	C	4				x	x
RiskReduction	F	1		“Risk reducing” indicator for Commodity derivatives			x

6.4.15 Trade, Trade Amendment or Cancellation 2 Legs Private Information (MsgType = 0x1E)

Sent by the server to inform about a trade produced due to any reason other than order matching. The user is involved in the trade both as Buyer and Seller. It is also sent to inform about the amendment or cancellation of whatever origin trade where the user is involved both as Buyer and Seller.

Field	Type	Length	Valid values	Description	R F	R V	D E
MessageSize	U	2		Length of message, including this field	x	x	x
MessageType	U	1		Message type	x	x	x
SequenceNumber	U	4		Message sequence number	x	x	x
SecurityCode	U	4		Instrument (or Book) code	x	x	x
TransactionDateAndTime	T	8		Transaction Date and Time in nanoseconds since 1-jan-1970 UTC	x	x	x
MarketSegmentID	C	4		MIC Code	x	x	x
TradingSessionID	U	1	See Table 25 – TradingSessionID in “BMEGate Codification Tables”	Trading mode	x	x	x
TrdMatchID	U	4		System Trade Number	x	x	x
TradeType	C	1	See Table 4 – Trade types in “BMEGate Codification Tables”	Trade type	x	x	x
LastPX	P	8		Trade price	x	x	x
LastQty	Q	4		Current trade volume	x	x	x
GrossTradeAmt	A	8		Premium / Trade amount	x	x	x
Designation	C	1	'1' Trade during Open Market '2' Trade during Opening Auction '3' Trade during Closing Auction '4' Trade during volatility auction '5' Trade during manual auction '6' Trade during opening auction extension '7' Trade during closing auction extension '8' Trade during TAL period	Trade situation	x	x	x
MarketMechanism	C	1	See Table 28 – Level 1	Market Mechanism	x	x	x
AlgoFlag	F	1	Flag ALGO RTS1	Algorithmic flag indicator	x	x	x
BuyerBolsaCode	C	1	See Table 15 – Bolsa code belonging to the member (buy side) in “BMEGate Codification Tables”	Stock Exchange code of the buyer		x	
AltLastPX	P	8		Trade yield or percent of par	x		
AccruedInterestAmt	A	8		Accrued Interest amount	x		

Field	Type	Length	Valid values	Description	R F	R V	D E
AccruedInterestRate	P	8		Interest rate of coupon	x		
SettlDate	D	4		Settlement date	x	x	
TransactionCategory	C	1	See Table 28 – Level 3.1		x	x	x
StrategyTrdMatchID	U	4		System Trade Number of the time-spread or strategy			x
LastChangeFlag	B	1		Indicates if this trade changes the instrument Last price	x	x	x
BENC_RFPT_Flag	C	1	See Table 28 – Levels 3.5, 3.11 and 3.12	Benchmark or Reference Price Indicator MMT	x	x	x
TradePriceCondition	C	1	See Table 28 – Level 3.8	MMT 3.8	x	x	x
PreTradeTransparencyWaiver	C	1	See Table 28 – Levels 3.2 and 3.10	Pre-trade transparency waiver	x	x	x
DeferralWaiver	C	1	See Table 28 – Levels 4.1, 4.3 and 4.4	Deferral Waiver	x	x	x
PostDeferralPublicationType	C	1	See Table 28 – Level 4.2	Post-deferral publication type	x		x
PublishDateAndTime	T	8		Publication Date and Time in nanoseconds since 1-jan-1970 UTC	x	x	x
TradeDate	T	8		Trade date and time	x	x	x
TradeSessionDate	D	4		Trade Session Date	x	x	x
SettlDate2	D	4		Settlement date of the second leg	x		
EndCash	A	8		Amount to be settled at the end of the Repo Trade	x		
VolumeFloat	V	8		Volume with decimal places		x	
SICAVFundCounterpartySide	C	1	'1' = Buyer '2' = Seller ' ' = N/A	Indicates the side of the Counterparty member in a SICAV or Mutual Fund			x
AmendedTradeType	C	1	See Table 4 – Trade types in “BMEGate Codification Tables	Trade type of the amended/cancelled trade	x	x	x
ExecRefID	U	4		System Trade Number of the amended/cancelled trade	x	x	x
AmendedTradeDate	D	4		Date of the amended/cancelled trade	x	x	x
Broker	C	4					x
BrokerTrader	C	3			x		x
BrokerText	C	15			x		x
SecondaryOrderID	U	4		System Order Number	x	x	x

Field	Type	Length	Valid values	Description	R F	R V	D E
EntryDate	D	4		System order entry date (when System Order Number was assigned)	x	x	x
Priority	U	4		Priority	x	x	x
Price	P	8		Limit price	x	x	x
DisplayQty	Q	4		Visible pending volume	x	x	x
AltPrice	P	8		Yield or percent of par	x		
OrderID	U	4		Application Order ID (unique at security level)	x	x	x
SecondaryExecID	U	4		History number	x	x	x
OrderQty	Q	4		Total order volume	x	x	x
OrdStatus	C	1	0 = Pending (no volume filled) 8 = Rejected 1 = Partially filled 2 = Totally Filled 4 = Cancelled (not filled) P= Cancelled (partially filled) A = Non-working order (Pending validation) S = Non-working order (Pending activation)	Order Status	x	x	x
CCPCode	C	1	'0' - N/A '1' - BME Clearing ... Others to be defined	CCP Code	x	x	x
AggressorIndicator	C	1	': N/A P: Passive A: 138assive138ve	Passive or aggressive indicator	x	x	x
RequestID	U	4		Request ID (for application feedback)	x	x	x
ClientDataID	U	2	1-65535 (in response messages, 0 means no ClientDataID used)	Client Data ID (to be used as a shortcode in orders and quotes)	x	x	x
AlgorithmicTradeIndicator	F	1		Algorithmic flag indicator	x	x	x
ClientID	U	4		Mifid II ClientID	x	x	x
AccountBoles	C	16		Client code	x	x	
Account	C	5		Account	x	x	x
DEAFlag	F	1		Direct Electronic Access indicator	x	x	x
DecisorID	U	4		MIFID II DecisorID	x	x	x
ExecutorID	U	4		Mifid II ExecutorID	x	x	x

Field	Type	Length	Valid values	Description	R F	R V	D E
LiquidityProvisionActivity	F	1		Liquidity Provision Activity Flag	x	x	x
GiveInMember	C	4		Give-in member		x	x
AccountMember	C	4			x		
FirmMnemonic	C	10				x	x
AllocText	C	18				x	x
LastCapacity	C	1	D=Dealing on own account M=Matched principal A=Any Other Trading Capacity blank		x	x	x
SelfMatchPreventionID	U	2				x	x
AutomaticOrderFilterFlag	C	1	2 - For orders entered by an authorized trader g - For authorized arbitration orders C - For orders not entered by an authorized trader '' - N/A			x	
ReceivedDepositID	C	1	I = Orders placed through the Internet B = Orders placed through the bank branch network T = Orders placed through automatic trading systems C = Orders placed by important clients O = Others '' = N/A (Workstation)			x	
Persistence	C	1	C - Cancel on disconnection P - Persist on disconnection	Persistence type	x	x	x
AccountType	C	1	9 = Retail Service Specialist 33 = Retail customer (Supported for compatibility): A = On behalf of third parties P = House trader E = Specialist	Capacity Indicator		x	
SelfMatchPreventionType	C	1	'' = N/A or default behaviour (aggressive order is rejected) 1 = Reject aggressive order 2 = Cancel 139assive order 3 = Cancel both passive and aggressive order			x	x
Member	C	4		Member	x	x	x

Field	Type	Length	Valid values	Description	R F	R V	D E
Trader	C	3		Trader	x	x	x
SubMember	C	1		Submember code	x	x	x
CrossId	U	4		Cross Trade Unique Identifier	x	x	x
BolsaCode	C	1	See Table 15 – Bolsa code belonging to the member (buy side) in “BMEGate Codification Tables”	Bolsa code (Madrid, Barcelona, Bilbao, Valencia)		x	
CSDBIC	C	11		BIC of the Central Securities Depository		x	
Participant	C	11		Participant		x	
CtaLiq	C	35		Securities Account code in CSD		x	
CCV	C	20		Securities Account code in CSD		x	x
OrderSecurityCode	U	4		Order instrument (or Book) code	x	x	x
ExternalMember	C	4				x	x
RiskReduction	F	1		“Risk reducing” indicator for Commodity derivatives			x
SecondaryOrderID2	U	4		System Order Number	x	x	x
EntryDate2	D	4		System order entry date (when System Order Number was assigned)	x	x	x
Priority2	U	4		Priority	x	x	x
Price2	P	8		Limit price	x	x	x
DisplayQty2	Q	4		Visible pending volume	x	x	x
AltPrice2	P	8		Yield or percent of par	x		
OrderID2	U	4		Application Order ID (unique at security level)	x	x	x
SecondaryExecID2	U	4		History number	x	x	x
OrderQty2	Q	4		Total order volume	x	x	x
OrdStatus2	C	1	0 = Pending (no volume filled) 8 = Rejected 1 = Partially filled 2 = Totally Filled 4 = Cancelled (not filled) P= Cancelled (partially filled) A = Non-working order (Pending validation) S = Non-working order (Pending activation)	Order Status	x	x	x
CCPCode2	C	1	'0' – N/A '1' – BME Clearing ... Others to be defined	CCP Code	x	x	x

Field	Type	Length	Valid values	Description	R F	R V	D E
AggressorIndicator2	C	1	': N/A P: Passive A: 141assive141ve	Passive or aggressive indicator	x	x	x
RequestID2	U	4		Request ID (for application feedback)	x	x	x
ClientDataID2	U	2	1-65535 (in response messages, 0 means no ClientDataID used)	Client Data ID (to be used as a shortcode in orders and quotes)	x	x	x
AlgorithmicTradeIndicator2	F	1		Algorithmic flag indicator	x	x	x
ClientID2	U	4		Mifid II ClientID	x	x	x
AccountBolsa2	C	16		Client code	x	x	
Account2	C	5		Account	x	x	x
DEAFlag2	F	1		Direct Electronic Access indicator	x	x	x
DecisorID2	U	4		MIFID II DecisorID	x	x	x
ExecutorID2	U	4		Mifid II ExecutorID	x	x	x
LiquidityProvisionActivity2	F	1		Liquidity Provision Activity Flag	x	x	x
GiveInMember2	C	4		Give-in member		x	x
AccountMember2	C	4			x		
FirmMnemonic2	C	10				x	x
AllocText2	C	18				x	x
LastCapacity2	C	1	D=Dealing on own account M=Matched principal A=Any Other Trading Capacity blanco		x	x	x
SelfMatchPreventionID2	U	2				x	x
AutomaticOrderFilterFlag2	C	1	2 - For orders entered by an authorized trader g - For authorized arbitration orders C - For orders not entered by an authorized trader ' - N/A			x	
ReceivedDeptID2	C	1	I = Orders placed through the Internet B = Orders placed through the bank branch network T = Orders placed through automatic trading systems C = Orders placed by important clients			x	

Field	Type	Length	Valid values	Description	R F	R V	D E
			O = Others '' = N/A (Workstation)				
Persistence2	C	1	C - Cancel on disconnection P - Persist on disconnection	Persistence type	x	x	x
			9 = Retail Service Specialist 33 = Retail customer				
AccountType2	C	1	(Supported for compatibility): A = On behalf of third parties P = House trader E = Specialist	Capacity Indicator			x
			'' = N/A or default behaviour (aggressive order is rejected)				
SelfMatchPreventionType2	C	1	1 = Reject aggressive order 2 = Cancel 142assive order 3 = Cancel both passive and aggressive order			x	x
Member2	C	4		Member	x	x	x
Trader2	C	3		Trader	x	x	x
SubMember2	C	1		Submember code	x	x	x
CrossId2	U	4		Cross Trade Unique Identifier	x	x	x
BolsaCode2	C	1	See Table 15 - Bolsa code belonging to the member (buy side) in "BMEGate Codification Tables"	Bolsa code (Madrid, Barcelona, Bilbao, Valencia)			x
CSDBIC2	C	11		BIC of the Central Securities Depository			x
Participant2	C	11		Participant			x
CtaLiq2	C	35		Securities Account code in CSD			x
CCV2	C	20		Securities Account code in CSD	x	x	
OrderSecurityCode2	U	4		Order instrument (or Book) code	x	x	x
ExternalMember2	C	4					x
RiskReduction2	F	1		"Risk reducing" indicator for Commodity derivatives			x

6.4.16 Business message reject (MsgType = 0x6A)

It may be sent by the server to inform about the rejection of a supported message that is syntactically correct in an unsupported situation.

Field	Type	Length	Valid values	Description	R F	R V	DE
MessageSize	U	2		Length of message, including this field	x	x	x
MessageType	U	1	0x6A	Message type	x	x	x
Sequence Number	U	4		Message sequence number	x	x	x
TransactionDateAndTime	T	8		Transaction Date and Time in nanoseconds since 1-jan-1970 UTC	x	x	x
RefMsgType	U	1		Type of message responded to	x	x	x
BusinessRejectReason	U	1	0 = Other 3 = Unsupported Message Type 30 = Invalid ClientDataID 31 = Sponsored Access 32 = Quote Operation Rejected 33 = Invalid Security	Reason for rejection	x	x	x
Text	C	65		Explanation of rejection. When BusinessRejectReason = 31, the first two characters of this string will contain the specific sponsored access reject code as specified in "Sponsored Access User Manual"	x	x	x
RequestID	U	4		Request ID (for application feedback)	x	x	x

7 Combined Market Information and Order Entry scenarios

7.1 Binary messages handling internals

When handling a message coming from a client application, the Gateway Server will add to the message some additional information related to the user who entered the message, which is required for validation purposes, and will forward the message to the appropriate Trading Engine. The BME trading system will handle the incoming messages in the binary format.

The BME trading system will publish the outgoing messages in binary format, but in many cases, the message will be longer than what appears in this document. The Gateway is going to take specific parts of the message for its appropriate distribution to each party.

7.2 Some scenarios

In this section, different typical scenarios are analysed.

7.2.1 Order entry and publication

In this diagram a client application that is only connected to the Order Entry server sends an Order that goes into the order book without matching any other order.

The Order Entry Server sends a Simple Order Status (MsgType = 0x02) to the Client Application to confirm the order.

Users connected to Full-Depth feed receive an Order Market Pre-Transparency Information (Msg Type = 0x03) message, whereas users connected to Top-of-Book feeds receive a Top-of-book message.

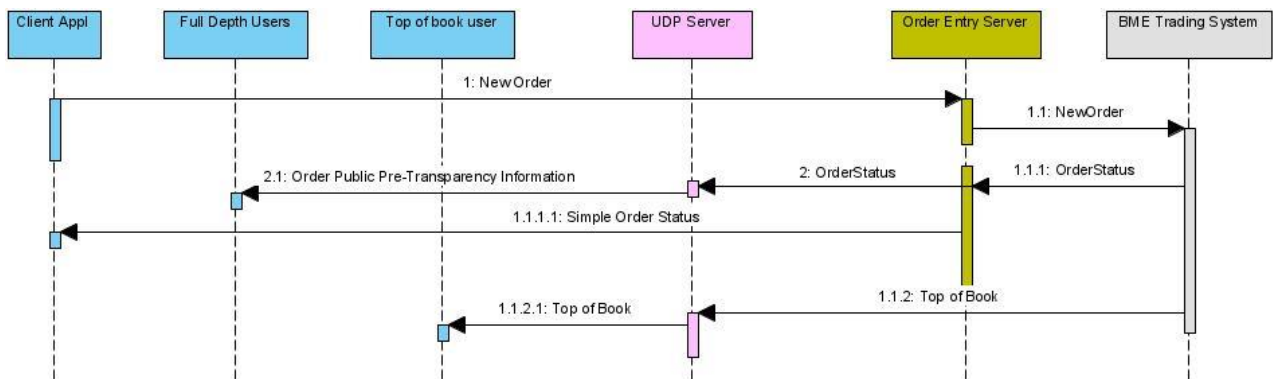

7.2.2 Order entry matching another order or a quote

In this diagram a client application that is only connected to the Order Entry server sends a buying Order that matches another order on the book. The counterparty is also connected to the Order Entry Server.

Several types of answer will be produced by different Servers:

- Order Entry Server: The application who entered the order will receive a Simple Order Status (MsgType = 0x02) followed by an Execution Private Information 1 Leg Buy (Order Entry) (MsgType = 0x12) with the data of the execution and his order (regardless of whether the order is partially or fully executed). If the counterparty is also connected to the same kind of server, it will also receive the same kind of message.

UDP Server for channels A/B: It will send an Order Market Pre-Transparency Information (Msg Type = 0x03) followed by a Trade Market Post-Transparency Information Full-Depth (Msg Type = 0x11) message.

UDP Server for channels C/D or E/F: It will send a Trade Market Post-Transparency Information Top-of-book (Msg Type = 0x10) message, then it will send a Top-of-book (Msg Type = 0x82) or Top-of-book 5 levels (Msg Type = 0x83) message, depending on the channel.

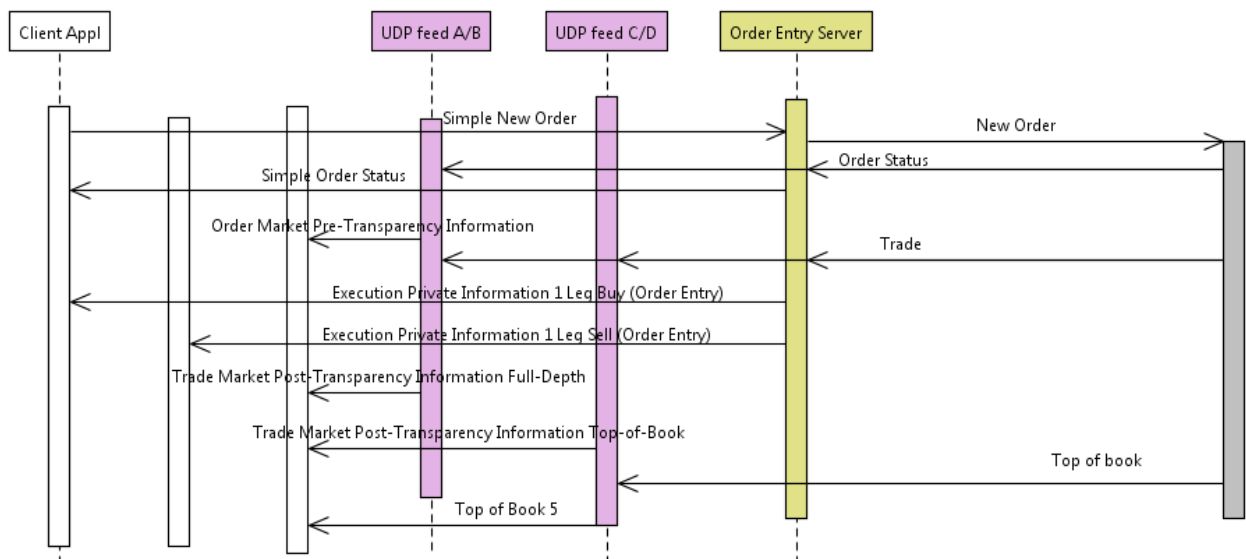

7.3 Comparison of related messages

7.3.1 Order related response messages

The following table compares the fields included in:

- Order Cancellation Market/Member (Msg Type = 0x01) (OC),
- Order Market Pre-Transparency Information (Msg Type = 0x03)(OPPI)
- Simple Order Status (MsgType = 0x02) (SOS)

Field	Type	Length	Description	R F	R V	D E	O C	O P P I	S O S
MessageSize	U	2	Length of message, including this field	x	x	x	x	x	x
MessageType	U	1	Message type	x	x	x	x	x	x
SequenceNumber	U	4	Message sequence number	x	x	x	x	x	x
SecurityCode	U	4	Instrument (or Book) code	x	x	x	x	x	x
TransactionDateAndTime	T	8	Transaction Date and Time in nanoseconds since 1-jan-1970 UTC	x	x	x	x	x	x
SecondaryOrderID	U	4	System Order Number	x	x	x	x	x	x
Side	C	1	Side	x	x	x		x	x
Priority	U	4	Priority	x	x	x		x	x
Price	P	8	Limit price	x	x	x		x	x
DisplayQty	Q	4	Visible pending volume	x	x	x		x	x
AltPrice	P	8	Yield or percent of par	x				x	x
RetailCIFlag	F	1	Retail Client Indicator			x		x	
OrderID	U	4	Application Order ID (unique at security level)	x	x	x		x	x
SecondaryExecID	U	4	History number	x	x	x			x
OrderQty	Q	4	Total order volume	x	x	x			x
OrdStatus	C	1	Order Status	x	x	x			x
OrdRejReason	C	1	Reason	x	x	x			x
ExecType	C	1	Confirmation type	x	x	x			x
RequestID	U	4	Request ID (for application feedback)	x	x	x			x
ClientDataID	U	2	Client Data ID (to be used as a shortcode in orders and quotes)	x	x	x			x

7.3.2 Quote related response messages

The following table compares the fields included in:

- Quote Cancellation Market/Member (Msg Type = 0x05)(QC),
- Quote Market Pre-Transparency Information (Msg Type = 0x07)(QPPI)
- Quote Status (MsgType = 0x06) (QS)

Field	Type	Length	Description	R F	R V	D E	Q C	Q P I	Q S
MessageSize	U	2	Length of message, including this field	x	x	x	x	x	x
MessageType	U	1	Message type	x	x	x	x	x	x
SequenceNumber	U	4	Message sequence number	x	x	x	x	x	x
SecurityCode	U	4	Instrument (or Book) code	x	x	x	x	x	x
TransactionDateAndTime	T	8	Transaction Date and Time in nanoseconds since 1-jan-1970 UTC	x	x	x	x	x	x
SecondaryOrderID	U	4	System Order Number	x	x	x	x	x	x
SecondaryOrderID2	U	4	System Order Number	x	x	x	x	x	x
Priority	U	4	Priority	x	x	x		x	x
Price	P	8	Limit price	x	x	x		x	x
DisplayQty	Q	4	Visible pending volume	x	x	x		x	x
AltPrice	P	8	Yield or percent of par	x				x	x
Priority2	U	4	Priority	x	x	x		x	x
Price2	P	8	Limit price	x	x	x		x	x
DisplayQty2	Q	4	Visible pending volume	x	x	x		x	x
AltPrice2	P	8	Yield or percent of par	x				x	x
OrderID	U	4	Application Order ID (unique at security level)	x	x	x			x
SecondaryExecID	U	4	History number	x	x	x			x
OrderQty	Q	4	Total order volume	x	x	x			x
OrdStatus	C	1	Order Status	x	x	x			x
OrdRejReason	C	1	Reason	x	x	x			x
ExecType	C	1	Confirmation type	x	x	x			x
OrderID2	U	4	Application Order ID (unique at security level)	x	x	x			x
SecondaryExecID2	U	4	History number	x	x	x			x
OrderQty2	Q	4	Total order volume	x	x	x			x
OrdStatus2	C	1	Order Status	x	x	x			x
OrdRejReason2	C	1	Reason	x	x	x			x
ExecType2	C	1	Confirmation type	x	x	x			x
RequestID	U	4	Request ID (for application feedback)	x	x	x			x
ClientDataID	U	2	Client Data ID (to be used as a shortcode in orders and quotes)	x	x	x			x

7.3.3 Execution (order matching) related messages

The following table compares the fields included in:

- Trade Market Post-Transparency Information Top-of-book (Msg Type = 0x10) (TtoB),
- Trade Market Post-Transparency Information Full-Depth (Msg Type = 0x11) (TFD),
- Execution Private Information 1 Leg Buy (Order Entry) (MsgType = 0x12)(TP1LB),
- Execution Private Information 1 Leg Sell (Order Entry) (MsgType = 0x14) (TP1LS),
- Execution Private Information 1 Leg Buy (Market & Order) (MsgType = 0x13) (TP1LB'),
- Execution Private Information 1 Leg Sell (Market & Order) (MsgType = 0x15) (TP1LS'),
- Execution Private Information 2 Legs (MsgType = 0x17) (TP2L).

Field	Type	Length	Description	R F	R V	D E	T T O B	T F D	T P 1 L B	T P 1 L S	T P 1 L B ,	T P 1 L S ,	T P 2 L
MessageSize	U	2	Length of message, including this field	x	x	x	x	x	x	x	x	x	x
MessageType	U	1	Message type	x	x	x	x	x	x	x	x	x	x
SequenceNumber	U	4	Message sequence number	x	x	x	x	x	x	x	x	x	x
SecurityCode	U	4	Instrument (or Book) code	x	x	x	x	x	x	x	x	x	x
TransactionDateAndTime	T	8	Transaction Date and Time in nanoseconds since 1-jan-1970 UTC	x	x	x	x	x	x	x	x	x	x
MarketSegmentID	C	4	MIC Code	x	x	x	x	x	x	x	x	x	x
TradingSessionID	U	1	Trading mode	x	x	x	x	x	x	x	x	x	x
TrdMatchID	U	4	System Trade Number	x	x	x	x	x	x	x	x	x	x
TradeType	C	1	Trade type	x	x	x	x	x	x	x	x	x	x
LastPX	P	8	Trade price	x	x	x	x	x	x	x	x	x	x
LastQty	Q	4	Current trade volume	x	x	x	x	x	x	x	x	x	x
GrossTradeAmount	A	8	Premium / Trade amount	x	x	x	x	x	x	x	x	x	x
Designation	C	1	Trade situation	x	x	x	x	x	x	x	x	x	x
MarketMechanism	C	1	Market Mechanism	x	x	x	x	x	x	x	x	x	x
AlgoFlag	F	1	Algorithmic flag indicator	x	x	x	x	x	x	x	x	x	x
BuyerBolsaCode	C	1	Stock Exchange code of the buyer		x		x	x	x	x	x	x	x
AltLastPX	P	8	Trade yield or percent of par	x			x	x	x	x	x	x	x
AccruedInterestAmt	A	8	Accrued Interest amount	x			x	x	x	x	x	x	x

Field	Type	Length	Description	R F	R V	D E	T T O B	T F D	T P 1 L B	T P 1 L S	T P 1 L B ,	T P 1 L S ,	T P 2 L
AccruedInterestRate	P	8	Interest rate of coupon	x			x	x	x	x	x	x	x
SettleDate	D	4	Settlement date	x	x		x	x	x	x	x	x	x
TransactionCategory	C	1	See Table 28 - Level 3.1	x	x	x	x	x	x	x	x	x	x
StrategyTradeMatchID	U	4	System Trade Number of the time-spread or strategy			x		x	x	x	x	x	x
SecondaryOrderID	U	4	System Order Number	x	x	x		x	x		x	x	x
EntryDate	D	4	System order entry date (when System Order Number was assigned)	x	x	x		x	x		x	x	x
Priority	U	4	Priority	x	x	x		x	x		x	x	x
Price	P	8	Limit price	x	x	x		x	x		x	x	x
DisplayQty	Q	4	Visible pending volume	x	x	x		x	x		x	x	x
AltPrice	P	8	Yield or percent of par	x				x	x		x	x	x
RetailFlag	F	1	Order/Quote only for retailers		x			x					x
RetailCIFlag	F	1	Retail Client Indicator			x		x					x
OrderID	U	4	Application Order ID (unique at security level)	x	x	x			x		x		x
SecondaryExecutionID	U	4	History number	x	x	x			x		x		x
OrderQty	Q	4	Total order volume	x	x	x			x		x		x
OrderStatus	C	1	Order Status	x	x	x			x		x		x
CCPCode	C	1	CCP Code	x	x	x			x		x		x
AggressorIndicator	C	1	Passive or aggressive indicator	x	x	x			x		x		x
RequestID	U	4	Request ID (for application feedback)	x	x	x			x		x		x
ClientDataID	U	2	Client Data ID (to be used as a shortcode in orders and quotes)	x	x	x			x		x		x
SecondaryOrderID2	U	4	System Order Number	x	x	x		x		x	x	x	x
EntryDate2	D	4	System order entry date (when System Order Number was assigned)	x	x	x		x		x	x	x	x
Priority2	U	4	Priority	x	x	x		x		x	x	x	x
Price2	P	8	Limit price	x	x	x		x		x	x	x	x
DisplayQty2	Q	4	Visible pending volume	x	x	x		x		x	x	x	x
AltPrice2	P	8	Yield or percent of par	x				x		x	x	x	x
RetailFlag2	F	1	Order/Quote only for retailers		x			x					
RetailCIFlag2	F	1	Retail Client Indicator			x		x					
OrderID2	U	4	Application Order ID (unique at security level)	x	x	x				x		x	x

Field	Type	Length	Description	R F	R V	D E	T T O B	T F D	T P 1 L B	T P 1 L S	T P 1 L B ,	T P 1 L S ,	T P 2 L
SecondaryExecID2	U	4	History number	x	x	x				x		x	x
OrderQty2	Q	4	Total order volume	x	x	x				x		x	x
OrdStatus2	C	1	Order Status	x	x	x				x		x	x
CCPCode2	C	1	CCP Code	x	x	x				x		x	x
AggressorIndicator2	C	1	Passive or aggressive indicator	x	x	x				x		x	x
RequestID2	U	4	Request ID (for application feedback)	x	x	x				x		x	x
ClientDataID2	U	2	Client Data ID (to be used as a shortcode in orders and quotes)	x	x	x				x		x	x

7.3.4 Trade due to reasons other than order matching related messages

The following table compares the fields included in:

- Trade, Trade Amendment or Cancellation (MsgType = 0x18) (TA),
- Trade, Trade Amendment or Cancellation 1 Leg Buy Private Information (MsgType = 0x1A) (TA1LB),
- Trade, Trade Amendment or Cancellation 1 Leg Sell Private Information (MsgType = 0x1C) (TA1LS)
- Trade, Trade Amendment or Cancellation 2 Legs Private Information (MsgType = 0x1E) (TA2L)

Field	Type	Length	Description	R F	R V	D E	T A	T A 1 L B	T A 1 L S	T A 2 L
MessageSize	U	2	Length of message, including this field	x	x	x	x	x	x	x
MessageType	U	1	Message type	x	x	x	x	x	x	x
SequenceNumber	U	4	Message sequence number	x	x	x	x	x	x	x
SecurityCode	U	4	Instrument (or Book) code	x	x	x	x	x	x	x
TransactionDateAndTime	T	8	Transaction Date and Time in nanoseconds since 1-jan-1970 UTC	x	x	x	x	x	x	x
MarketSegmentID	C	4	MIC Code	x	x	x	x	x	x	x
TradingSessionID	U	1	Trading mode	x	x	x	x	x	x	x
TrdMatchID	U	4	System Trade Number	x	x	x	x	x	x	x
TradeType	C	1	Trade type	x	x	x	x	x	x	x
LastPX	P	8	Trade price	x	x	x	x	x	x	x
LastQty	Q	4	Current trade volume	x	x	x	x	x	x	x
GrossTradeAmt	A	8	Premium / Trade amount	x	x	x	x	x	x	x
Designation	C	1	Trade situation	x	x	x	x	x	x	x
MarketMechanism	C	1	Market Mechanism	x	x	x	x	x	x	x
AlgoFlag	F	1	Algorithmic flag indicator	x	x	x	x	x	x	x
BuyerBolsaCode	C	1	Stock Exchange code of the buyer		x		x	x	x	x
AltLastPX	P	8	Trade yield or percent of par	x			x	x	x	x
AccruedInterestAmount	A	8	Accrued Interest amount	x			x	x	x	x
AccruedInterestRate	P	8	Interest rate of coupon	x			x	x	x	x
SettlDate	D	4	Settlement date	x	x		x	x	x	x
TransactionCategory	C	1	See Table 28 – Level 3.1	x	x	x	x	x	x	x
StrategyTrdMatchID	U	4	System Trade Number of the time-spread or strategy			x		x	x	x

Field	Type	Length	Description	R F	R V	D E	T A	T A 1 L B	T A 1 L S	T A 2 L
LastChangeFlag	F	1	Indicates if this trade changes the instrument Last price	x	x	x	x	x	x	x
BENC_RFPT_Flag	C	1	Benchmark or Reference Price Indicator MMT	x	x	x	x	x	x	x
TradePriceCondition	C	1	MMT level 3.8	x	x	x	x	x	x	x
PreTradeTransparencyWaiver	C	1	Pre-trade transparency waiver	x	x	x	x	x	x	x
DeferralWaiver	C	1	Deferral Waiver	x	x	x	x	x	x	x
PostDeferralPublicationType	C	1	Post-deferral publication type	x		x	x	x	x	x
PublishDateAndTime	T	8	Publication Date and Time in nanoseconds since 1-jan-1970 UTC	x	x	x	x	x	x	x
TradeDate	T	8	Trade date and time	x	x	x	x	x	x	x
TradeSessionDate	D	4	Trade Session Date	x	x	x	x	x	x	x
SettleDate2	D	4	Settlement date of the second leg	x			x	x	x	x
EndCash	A	8	Amount to be settled at the end of the Repo Trade	x			x	x	x	x
VolumeFloat	V	8	Volume with decimal places		x		x	x	x	x
SICAVFundCounterpartySide	C	1	Indicates the side of the Counterparty member in a SICAV or Mutual Fund		x		x	x	x	x
AmendedTradeType	C	1	Trade type of the amended/cancelled trade	x	x	x	x	x	x	x
ExecRefID	U	4	System Trade Number of the amended/cancelled trade	x	x	x	x	x	x	x
AmendedTradeDate	D	4	Date of the amended/cancelled trade	x	x	x	x	x	x	x
Broker	C	4				x	x	x	x	
BrokerTrader	C	3		x		x	x	x	x	
BrokerText	C	15		x		x	x	x	x	
SecondaryOrderID	U	4	System Order Number	x	x	x	x			x
EntryDate	D	4	System order entry date (when System Order Number was assigned)	x	x	x	x			x
Priority	U	4	Priority	x	x	x	x			x
Price	P	8	Limit price	x	x	x	x			x
DisplayQty	Q	4	Visible pending volume	x	x	x	x			x
AltPrice	P	8	Yield or percent of par	x			x			x
OrderID	U	4	Application Order ID (unique at security level)	x	x	x	x			x
SecondaryExecID	U	4	History number	x	x	x	x			x
OrderQty	Q	4	Total order volume	x	x	x	x			x
OrdStatus	C	1	Order Status	x	x	x	x			x
CCPCode	C	1	CCP Code	x	x	x	x			x

Field	Type	Length	Description	R F	R V	D E	T A	T A 1 L B	T A 1 L S	T A 2 L
AggressorIndicator	C	1		x	x	x		x		x
RequestID	U	4	Request ID (for application feedback)	x	x	x		x		x
ClientDataID	U	2	Client Data ID (to be used as a shortcode in orders and quotes)	x	x	x		x		x
AlgorithmicTradeIndicator	F	1	Algorithmic flag indicator	x	x	x		x		x
ClientID	U	4	Mifid II ClientID	x	x	x		x		x
AccountBolsa	C	16	Client code	x	x			x		x
Account	C	5	Account	x	x	x		x		x
DEAFlag	F	1	Direct Electronic Access indicator	x	x	x		x		x
DecisorID	U	4	MIFID II DecisorID	x	x	x		x		x
ExecutorID	U	4	Mifid II ExecutorID	x	x	x		x		x
LiquidityProvisionActivity	F	1	Liquidity Provision Activity Flag	x	x	x		x		x
GiveInMember	C	4	Give-in member		x	x		x		x
AccountMember	C	4		x				x		x
FirmMnemonic	C	10			x	x		x		x
AllocText	C	18			x	x		x		x
LastCapacity	C	1		x	x	x		x		x
SelfMatchPreventionID	U	2			x	x		x		x
AutomaticOrderFilterFlag	C	1			x			x		x
ReceivedDeptID	C	1			x			x		x
Persistence	C	1	Persistence type	x	x	x		x		x
AccountType	C	1	Capacity Indicator		x			x		x
SelfMatchPreventionType	C	1			x	x		x		x
Member	C	4	Member	x	x	x		x		x
Trader	C	3	Trader	x	x	x		x		x
SubMember	C	1	Submember code	x	x	x		x		x
CrossId	U	4	Cross Trade Unique Identifier		x			x		x
BolsaCode	C	1	Bolsa code (Madrid, Barcelona, Bilbao, Valencia)		x			x		x
CSDBIC	C	11	BIC of the Central Securities Depository		x			x		x
Participant	C	11	Participant		x			x		x
CtaLiq	C	35	Securities Account code in CSD		x			x		x
CCV	C	20	Securities Account code in CSD		x	x		x		x
OrderSecurityCode	U	4	Order instrument (or Book) code	x	x	x		x		x

Field	Type	Length	Description	R F	R V	D E	T A	T A 1 L B	T A 1 L S	T A 2 L
ExternalMember	C	4			x	x		x		x
RiskReduction	F	1	"Risk reducing" indicator for Commodity derivatives			x		x		x
SecondaryOrderID2	U	4	System Order Number	x	x	x			x	x
EntryDate2	D	4	System order entry date (when System Order Number was assigned)	x	x	x			x	x
Priority2	U	4	Priority	x	x	x			x	x
Price2	P	8	Limit price	x	x	x			x	x
DisplayQty2	Q	4	Visible pending volume	x	x	x			x	x
AltPrice2	P	8	Yield or percent of par	x					x	x
OrderID2	U	4	Application Order ID (unique at security level)	x	x	x			x	x
SecondaryExecID2	U	4	History number	x	x	x			x	x
OrderQty2	Q	4	Total order volume	x	x	x			x	x
OrdStatus2	C	1	Order Status	x	x	x			x	x
CCPCode2	C	1	CCP Code	x	x	x			x	x
AggressorIndicator2	C	1		x	x	x			x	x
RequestID2	U	4	Request ID (for application feedback)	x	x	x			x	x
ClientDataID2	U	2	Client Data ID (to be used as a shortcode in orders and quotes)	x	x	x			x	x
AlgorithmicTradeIndicator2	F	1	Algorithmic flag indicator	x	x	x			x	x
ClientID2	U	4	Mifid II ClientID	x	x	x			x	x
AccountBolsa2	C	16	Client code	x	x				x	x
Account2	C	5	Account	x	x	x			x	x
DEAFlag2	F	1	Direct Electronic Access indicator	x	x	x			x	x
DecisorID2	U	4	MIFID II DecisorID	x	x	x			x	x
ExecutorID2	U	4	Mifid II ExecutorID	x	x	x			x	x
LiquidityProvisionActivity2	F	1	Liquidity Provision Activity Flag	x	x	x			x	x
GiveInMember2	C	4	Give-in member		x	x			x	x
AccountMember2	C	4		x					x	x
FirmMnemonic2	C	10			x	x			x	x
AllocText2	C	18			x	x			x	x
LastCapacity2	C	1		x	x	x			x	x
SelfMatchPreventionID2	U	2			x	x			x	x
AutomaticOrderFilterFlag2	C	1			x				x	x
ReceivedDeptID2	C	1			x				x	x

Field	Type	Length	Description	R F	R V	D E	T A	T A 1 L B	T A 1 L S	T A 2 L
Persistence2	C	1	Persistence type	x	x	x			x	x
AccountType2	C	1	Capacity Indicator		x				x	x
SelfMatchPreventionType2	C	1			x	x			x	x
Member2	C	4	Member	x	x	x			x	x
Trader2	C	3	Trader	x	x	x			x	x
SubMember2	C	1	Submember code	x	x	x			x	x
CrossId2	U	4	Cross Trade Unique Identifier		x				x	x
BolsaCode2	C	1	Bolsa code (Madrid, Barcelona, Bilbao, Valencia)		x				x	x
CSDBIC2	C	11	BIC of the Central Securities Depository		x				x	x
Participant2	C	11	Participant		x				x	x
CtaLiq2	C	35	Securities Account code in CSD		x				x	x
CCV2	C	20	Securities Account code in CSD		x	x			x	x
OrderSecurityCode2	U	4	Order instrument (or Book) code	x	x	x			x	x
ExternalMember2	C	4			x	x			x	x
RiskReduction2	F	1	"Risk reducing" indicator for Commodity derivatives			x			x	x

This material has been prepared by Bolsas y Mercados Españoles, Sociedad Holding de Mercados y Sistemas Financieros S. A. (BME), its subsidiaries, affiliates and/or their branches (together, "BME") for the exclusive use of the persons to whom BME delivers this material. This material or any of its content is not to be construed as a binding agreement, recommendation, investment advice, solicitation, invitation or offer to buy or sell financial information, products, solutions or services. The information does not reflect the firm positions (proprietary or third party) of the entities involved in the Spanish Securities Market. BME is under no obligation to update, revise or keep current the content of this material, and is subject to change without notice at any time. No representation, warranty, guarantee or undertaking – express or implied – is or will be given by BME as to the accuracy, completeness, sufficiency, suitability or reliability of the content of this material.

The opinions presented are theoretical and, therefore, the content hereof is intended for informational purposes only and should not be used for portfolio or asset valuations, or as the basis for any investment recommendations. Neither contributing Entities, nor Bolsas y Mercados Españoles, Sociedad Holding de Mercados y Sistemas Financieros S.A.(BME) nor any of its subsidiaries, accept responsibility for any financial loss or decision made based on the information contained in this material. In general, neither Bolsas y Mercados Españoles, Sociedad Holding de Mercados y Sistemas Financieros S. A. (BME) nor any of its subsidiaries, nor the contributing Entities, their directors, representatives, associates, subsidiaries, managers, partners, employees or advisors accept any responsibility for this information or unauthorised use of the same.

This material is property of BME and may not be printed, copied, reproduced, published, passed on, disclosed or distributed in any form without the express prior written consent of BME.

2023 Bolsas y Mercados Españoles, Sociedad Holding de Mercados y Sistemas Financieros S. A. All rights reserved.

BME
Plaza de la Lealtad,1
Palacio de la Bolsa
28014 Madrid

www.bolsasymercados.es

